

Data Processing on Modern Hardware

Jana Giceva

Lecture 7: Multicore CPUs

Parallelization and Synchronization



The rise of the multi-core machines

42 Years of Microprocessor Trend Data

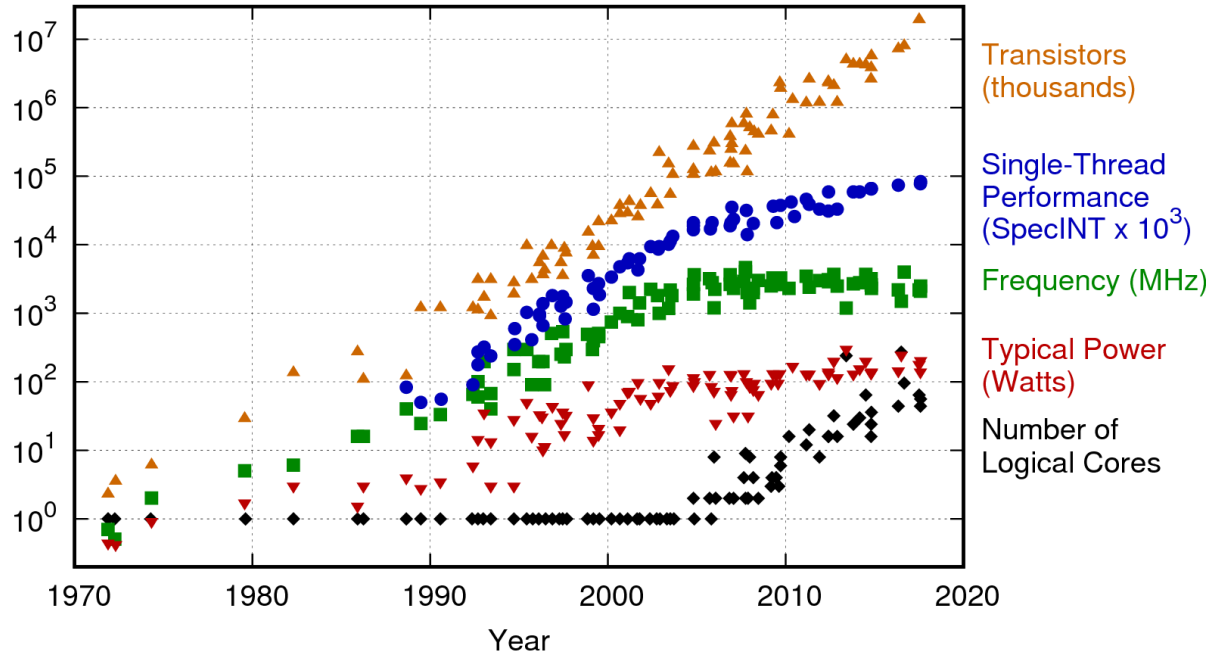

Original data up to the year 2010 collected and plotted by M. Horowitz, F. Labonte, O. Shacham, K. Olukotun, L. Hammond, and C. Batten
New plot and data collected for 2010-2017 by K. Rupp

- To make the most out of multicore processors we can:
 - Allow multiple different tasks to be running concurrently → **concurrency** (*multiprogramming*)
 - Parallelize the implementation of a single task → **parallelism** (*parallel programming*)

Parallelism

Basic concepts

- **Work partitioning** (expressing parallelism)

- **Work** must be split in **parallel tasks**
- Also known as domain decomposition

- **Scheduling**

- Tasks must be mapped into execution contexts

- **Task granularity**

- How much work a task performs?
- Too little → large overhead
- Too much → difficult for efficient load balancing

- **Correctness**

- Order of reads and writes is non-deterministic
- **Synchronization** is required to enforce the order

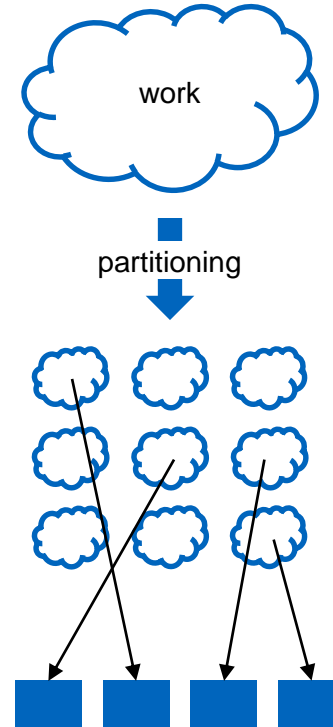

- An overloaded concept:
 - e.g., how well a system reacts to increased load, e.g., clients in a server
- **Speed-up** – how well does the RT reduces for the same problem size by adding resources (e.g., cores).
 - Speed up for problem size X with N resources: $SpeedUp(N) = RT(1, X) / RT(N, X)$
 - *Ideal*: linear function
- **Scale-up** – how well the system deals with larger load (problem size) by adding resources
 - Scale up for $N \times$ larger problem by adding $N \times$ resources: $ScaleUp(N) = RT(1, X) / RT(N, NX)$
 - *Ideal*: constant function
- **Scale-out** – how well the system deals with larger load (problem size) by adding more servers / machines
 - Scale out for $N \times$ larger problem by executing on $N \times$ machines: $ScaleOut(N) = TP(1, x) / TP(N, NX)$
 - *Ideal*: constant function (should behave like Scale-up)

Our focus: speed-up

- Sequential execution time: T_1
- Execution time T_p on p CPUs
- **(parallel) speed-up S_p on p CPUs:** $S_p = \frac{T_1}{T_p}$
 - $S_p = p$: linear speed-up
 - $S_p < p$: sub-linear speed-up / performance loss
 - $S_p > p$: super-linear speed-up / usually poor baseline
- **Why $S_p < p$?**
 - Programs may not contain enough parallelism
 - Some parts may be inherently sequential
 - Overheads due to parallelization
 - Typically associated with synchronization
 - Architectural limitations
 - Memory contention (memory bound)

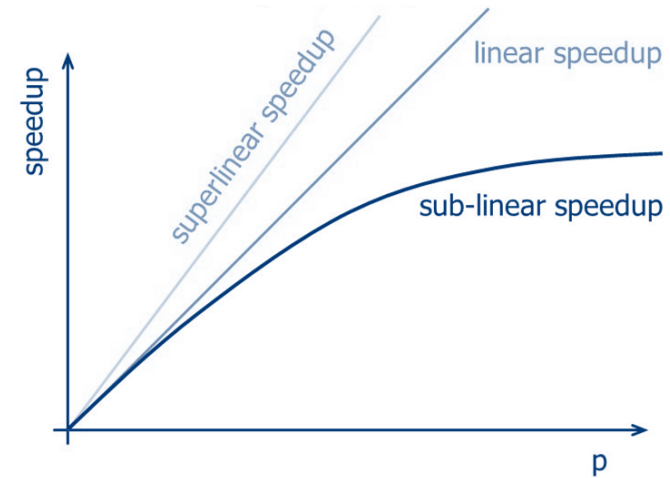

Amdahl's Law

Suppose we parallelize an algorithm using n cores and p is the proportion of the task that can be parallelized ($1 - p$ cannot be parallelized)

- The speed up of the algorithm is $\frac{1}{(1-p) + \frac{p}{n}}$
- For infinite parallelism, the speed-up is $\frac{1}{(1-p)}$
- For example, if 90% of the work is parallelized, the maximum speed up is 10
- Ensure that every phase of one's algorithm that depends on the input data size is parallelized.

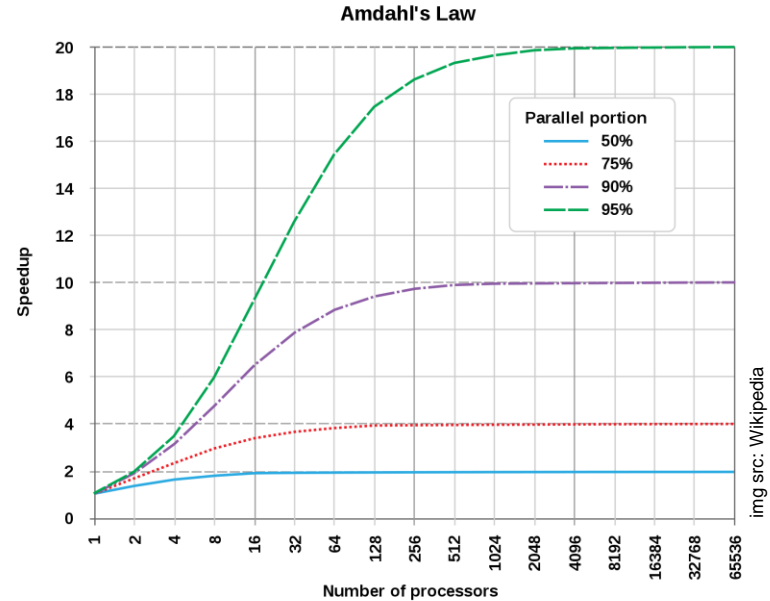

Pitfalls in parallel code



- **Non-scalable algorithm**

- Rethink the algorithm
- e.g., searching a tree: which one is easier to parallelize BFS or DFS?

- **Load imbalance**

- Break work into smaller tasks, dynamically schedule these between threads

- **Task overhead**

- Set a minimum per-thread task size (not too small, not too large)

Parallelize database workloads

In database systems:

- **Inter-query parallelism** (Concurrency, Multi-programming)
 - Requires a sufficient number of **co-running queries**.
 - May work well for **OLTP workloads**
 - Characterized by many simple queries
 - Data analytics / OLAP are resource-heavy
 - Will not help an individual query
- **Intra-query parallelism**
 - Intra-query parallelism is a must
 - Should still allow a few **co-running queries**.

- **Processes, kernel- and user-level threads and fibers**

- **Process:** an instance of a program that is isolated from other processes on the machine.
 - Has its own private section of the machine's memory.
 - A process abstraction is a virtual computer. Scheduled by the kernel.
- **Thread:** a locus of control inside a running program.
 - A thread abstraction is a virtual processor. Scheduled by the kernel.
 - Threads share all the memory in the process.
- **User-level threads:** act like threads, but implemented in user-space.
 - Can be scheduled preemptively or cooperatively. Invisible to the kernel.
- **Fibers:** light-weight thread of execution that uses co-operative multi-tasking.
 - Fibers yield themselves to run another fiber while executing.

- **OS Process per DBMS worker**

- Used by early DBMS implementations
- DBMS workers are mapped directly onto OS processes

- **OS Thread per DBMS worker**

- Single multi-threaded processes hosts all DBMS worker activity
- A dispatcher thread listens for new connections. Each connection is allocated a new thread.

- **DBMS Threads**

- Lightweight user-space threading constructs (replacing the need for OS threads)
- Fast task switching at the expense of replicating a good deal of the OS logic in the DBMS
 - Task-switching, thread state management, scheduling, etc.

- **Are co-routines (fibers) next?**

Parallelize database workloads

In database systems:

- **Inter-query parallelism** (Concurrency, Multi-programming)
 - Requires a sufficient number of **co-running queries**.
 - May work well for **OLTP workloads**
 - Characterized by many simple queries
 - Data analytics / OLAP are resource-heavy
 - Will not help an individual query
- **Intra-query parallelism**
 - Intra-query parallelism is a must
 - Should still allow a few **co-running queries**.

Volcano-style parallelism



Goal: Parallelize the query *engine* in a clean, uniform way.

Volcano's Solution: encapsulate the parallelism in a query *operator* of its own, not in the QP infrastructure.

Overview: kinds of intra-query parallelism available:

- pipeline
- partition, with two subcases:
 - intra-operator parallelism (e.g. parallel hash join, or parallel sort)
 - inter-operator parallelism -- bushy trees

We want to enable all -- including setup, teardown, and runtime logic -- in a clean encapsulated way.

The **exchange** operator:

- an operator you pop into any single-site dataflow graph as desired -- anonymous to the other operators.

Volcano-style parallelism

- Plan-driven approach:
 - Optimizer determines at compile time the degree of parallelism
 - Instantiates one query operator plan for each thread
 - Connects these with exchange operators, which encapsulate parallelism and manage threads
- Elegant model which is used by many systems

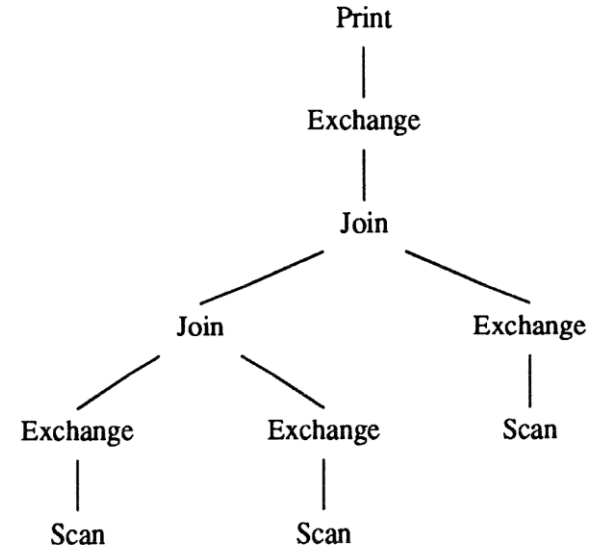

Volcano-style parallelism



- **Positive** aspects:
 - Operators are largely oblivious to parallelism

- **Drawbacks:**
 - Static work partitioning can cause **load imbalance**
 - **Degree of parallelism** cannot be easily change mid-query
 - **Potential overhead:**
 - Thread over-subscription causes context switching
 - Exchange operators create additional copies of the tuples

Parallelism in Modern DBMSs today

- **Query coordinator** manages the parallel execution
 - Obtains the number of parallel servers
 - Determines granularity of partitioning and load-distribution
- **Parallelism within and between operators**
 - Pipeline with depth 2 (producer – consumer pair)
 - e.g., parallel scan and group-by uses 8 servers in total.
- **DOP (degree of parallelism)** – the number of parallel execution servers associated with a single operator
 - Can be chosen **manually** or **automatic**
 - **Adaptive** means it can reduce the DOP as the load in the system increases

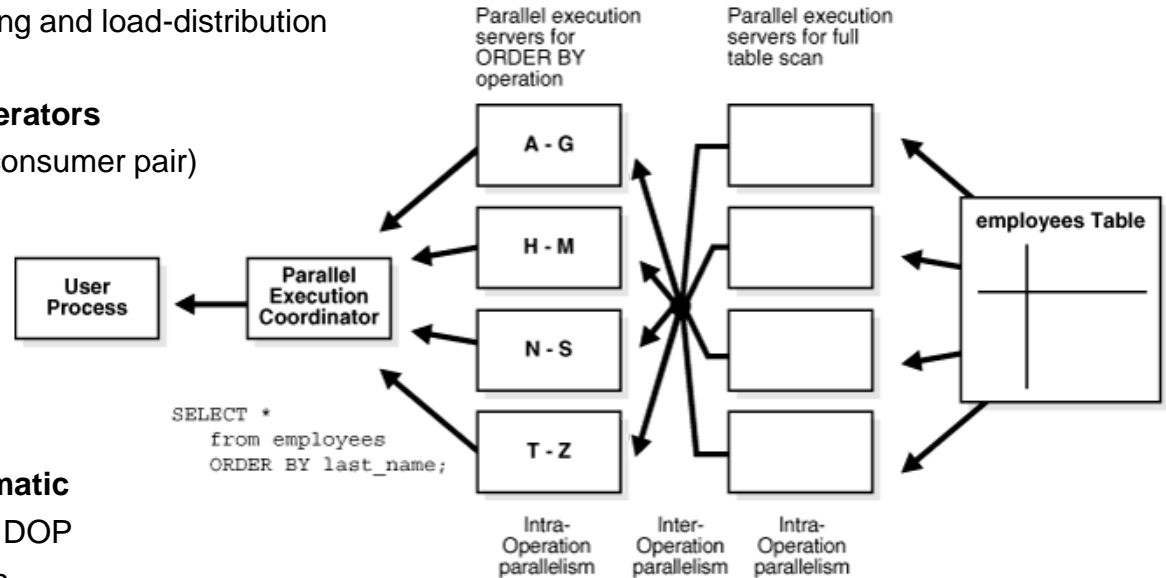

Inter-operator parallelism and dynamic scheduling

Parallelizing the radix join

- Use the **task queuing model** that decomposes the execution into **parallel tasks**, each executing a fraction of the total work
- The runtime system can then **dynamically** schedule the tasks on different **hardware threads T** .

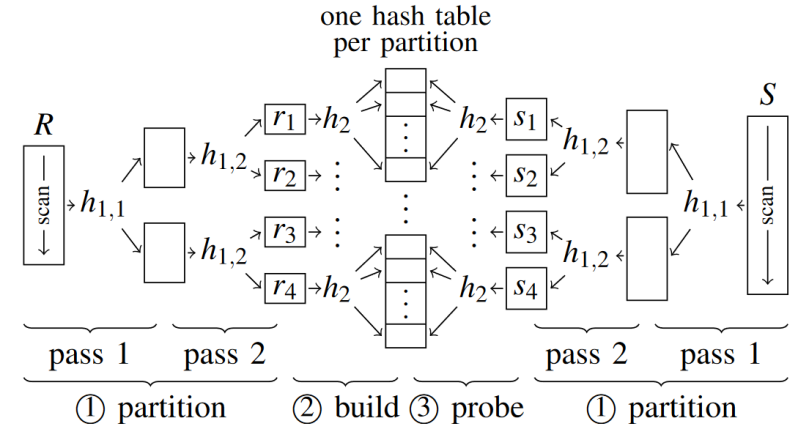

- General guidelines:
 - Create more tasks than there are threads
 - If a task's input size exceeds a threshold (e.g., due to skew):
 - Further split it up or if not possible put it aside and handle it afterwards
 - Ensure to have good load-balancing among the hardware threads.
- More details for the specific stages of the join in *Sort vs Hash Revisited: Fast Join Implementations on Modern Multicore CPUs* by Kim et al. (VLDB 2009)

Impact of task granularity on parallel operators

- Different stages in radix join:
 - 1 – 2: compute local histogram for R and S
 - 3 – 4: partitioning passes 1 and 2
 - 5: join phase (partition-wise build and probe)
- Evaluate the effect of task granularity and queuing on the performance of the radix join (zipf 1.5)
 - Left – simple task queuing
 - Right – task decomposition for large part/join tasks

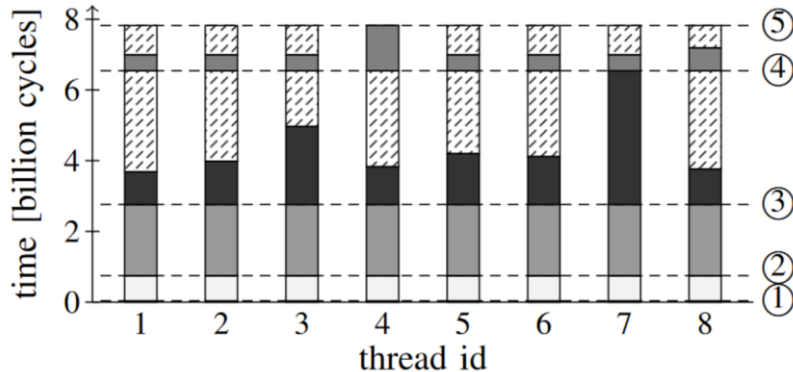

- All threads do useful work in the beginning of each execution stage (busy time with different gray shades)
- Simple task queuing leads to poor load-balancing and threads need to wait on barriers → 25% perf. reduction
- With fine-grained task decomposition, we can identify the large tasks and break them down for good load balancing among all the working threads.

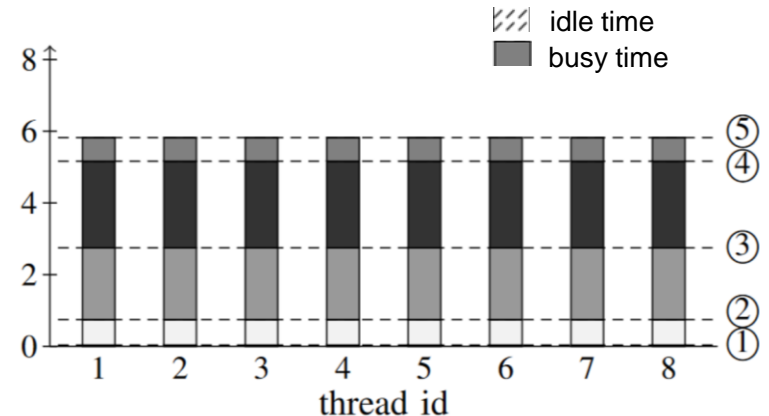

Lessons learned:

- Use **fine-grained partitioning**
 - Increased scheduling overhead seems bearable
- Assign partitions / tasks **dynamically** to processors
 - Make load balancing easier
- How to incorporate that at an engine level?
 - Morsel-driven parallelism (as implemented in HyPer)

Morsel-driven query execution

- Example of user-level task-based parallelism as framework in database systems.
- Break input data into **constant-sized work units** (“morsels”)
- **Dispatcher** assigns morsels and a pipeline (of operators) to worker threads (**scheduling**)
- Number of worker threads = number of hardware threads
- Operators are **designed for parallel execution**

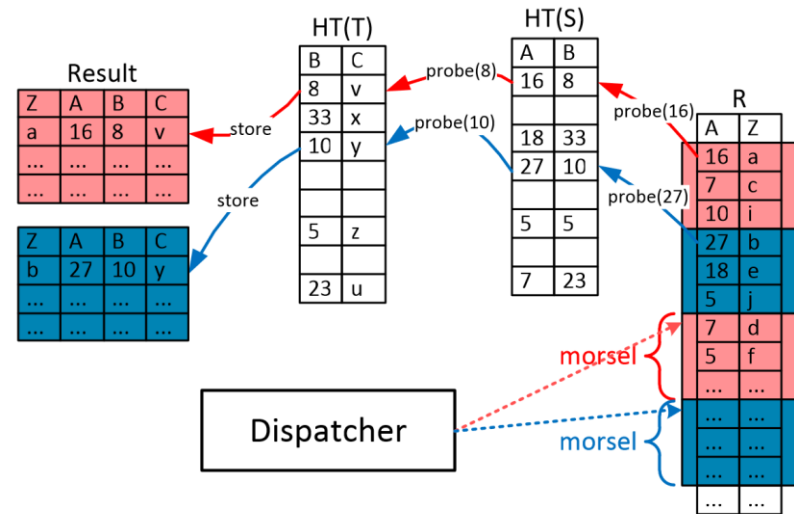
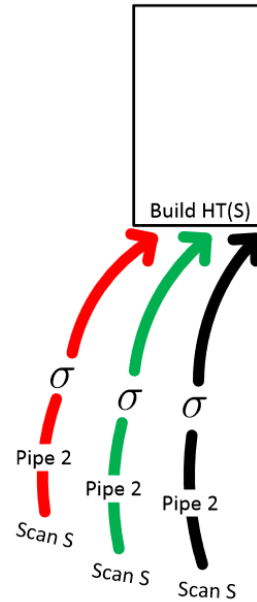
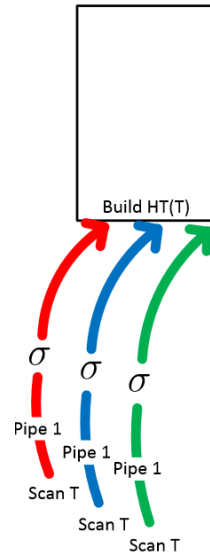
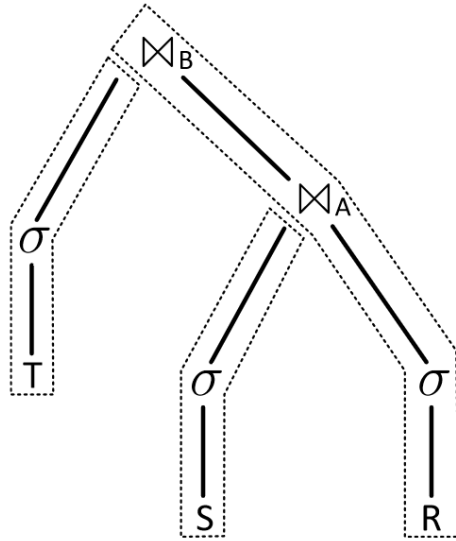

Figure 1: Idea of morsel-driven parallelism: $R \bowtie_A S \bowtie_B T$

Query pipeline parallelization

- Each pipeline is parallelized individually using all threads



Query pipeline parallelization

- Each pipeline is parallelized individually using all threads

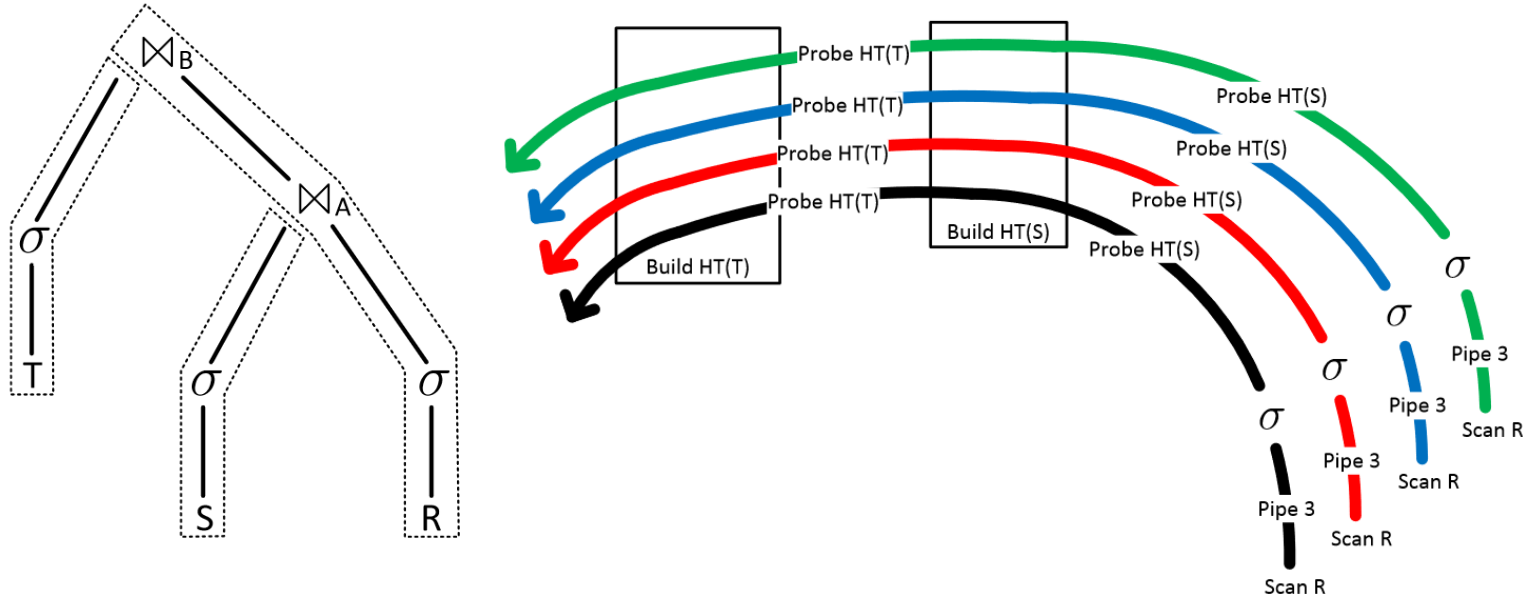

Concurrency and Synchronization

Concurrency in database workloads



Databases are often faced with **highly concurrent workloads**.

Good news:

- Exploit parallelism offered by the hardware (increasing number of cores)

Bad news:

- Increases relevance of **synchronization mechanisms**.

Synchronization in databases

Two levels of synchronization in databases:

- Synchronize on **user data** to guarantee **transactional semantics**:
 - database terminology: **locks**
- Synchronize on **database-internal data structures**
 - database terminology: **latches**

We will **focus** on the latter (**latches**), even when we refer to them as locks.

- Cores have **private caches**
- CPU manages the shared memory and private caches using a cache coherency protocol

Cache coherency protocol ensures the **consistency of data in caches**

- Implements the two fundamental operations: **load** and **store** using:
 - **Snooping-based** coherence
 - All processors communicate to agree on the state
 - **Directory-based** coherence
 - A centralized directory holds information about state/whereabouts of data items

Cache coherency protocol



- Most contemporary processors use the MESI cache coherency protocol (or a variant)
- MESI protocol has the following states:
 - *Modified*: cache line is only in current cache and has been modified
 - *Exclusive*: cache line is only in current cache and has not been modified
 - *Shared*: cache line is in multiple caches
 - *Invalid*: cache line is unused
- Intel uses the MESIF protocol, with an additional Forward state
 - Special shared state indicating a designated “responder”

- x86 provides a *lock* prefix that tells the hardware:
 - Do not let anyone read / write the value until I am done with it
 - Not the default case (because it is slow!)
- Compare-and-swap (CAS):
 - `lock cmpxchg`
- Exchange:
 - `xchg` (automatically locks the bus)
- Read-modify-write:
 - `lock add`
- If the compiler (or you) also emit code using non-temporal stores, it must also emit sufficient fencing to make the usage of non-temporal stores un-observable to callers/callees.
 - `_mm_mfence()`, `_mm_lfence()`, `_mm_sfence()`

There are different synchronization modes :

- **Pessimistic** locking
 - Always take an (exclusive) lock to access/modify data in the critical section
- **Optimistic** locking
 - Validate whether the data read in the critical section is still valid upon completion
- Lock-free
 - Threads never block for any reason when reading or writing
 - Leverage HW-support for synchronization (atomics)
- Speculative locking (hardware transactional memory (HTM))

Types of Locks

- There are many different types of locks (we only look at a subset)

- **Pessimistic:**

- *Exclusive* lock
 - Only one thread may hold the lock at a time
- *Shared* (Reader-Writer RW) lock
 - Permit any number of readers to hold the lock concurrently
 - Only allow a single writer to hold the lock

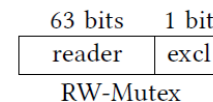
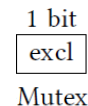

- **Optimistic:**

- Validate that the data read in the critical section has not changed

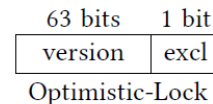

Optimistic locking

```
void readOptimistically(Lambda& readCallback){  
  
    // Attempt to read optimistically  
    for(i in [1 : MAX_ATTEMPTS]){  
        preVersion = getVersion();  
        if(isLocked(preVersion))  
            continue;  
        readCallback();  
        postVersion = getVersion();  
        if(preVersion == postVersion)  
            return;  
    }  
  
    // Fallback to pessimistic locking  
    lockPessimistic();  
    readCallback();  
    unlock();  
}
```

- Validate that the data read in the critical section has not changed in the meantime
- Good for frequently read data
 - avoids the expensive atomic writes required by pessimistic lock
 - cache invalidation only needed on writes
- Challenges:
 - Use it when it is safe to fail and restart
 - All operations must be restart-able w/o side-effects
 - With too much write contention, could lead to starvation

Lock (latch) implementation

There are two strategies to implement (pessimistic) locking:

- **Spinning** (in user space) – *e.g.*, spinlock
 - Waiting thread repeatedly polls lock until it becomes free
 - But, the thread burns CPU cycles while sleeping
 - Cost two cache miss penalties (if implemented well) → 150nsec
- **Blocking** (OS service) – *e.g.*, mutex or user-space futex
 - De-schedule the waiting thread until the lock becomes free
 - Cost: two context switches (one to sleep, one to wake-up) → 12-20usec

Requirements for latches in databases



- Most database workloads **mostly read data** (even OLTP workloads)
 - Reading should be fast and scalable
- For tree-based data structures (e.g., indexes), we always need to traverse the top levels of the tree
 - High contention on such **hotspots** – **should be lockable with minimal overhead**
- **Latency is critical**
 - Avoid context switching as much as possible → cannot solely rely on OS-based locks
- Some fine-grain data like index nodes or hash buckets requires **space efficient locks**
 - Standard mutex (`std::mutex`) can be as much as 40-80 bytes – double the size for an ART node
- **Efficient contention handling**
 - Handle contention gracefully, without sacrificing the uncontended path

Qualitative overview of locking modes

- Which locking mode is best for a certain type of workload?
 - **Workloads:** read-only, read-mostly (big/small read-set), write-heavy, write-only
 - **Locking modes:** pessimistic (exclusive, shared), optimistic

Workload Type	Exclusive	Shared	Optimistic
Read-Only	Too restrictive	“Read-Read Contention”	No Overhead
Read-Mostly: cheap reads	Too restrictive	Still some contention	Restarts unlikely and cheap
Read-Mostly: big read set	Too restrictive	Lock overhead diminishes	Restarts can be expensive
Write-Heavy	Restrictive	Good	Many Aborts/Starvation
Write-Only	Equally good (all writes are locked exclusively)		

Types of Locks

- There are many different types of locks (we only look at a subset)

- **Pessimistic:**

- *Exclusive* lock
 - Only one thread may hold the lock at a time
- *Shared* (Reader-Writer RW) lock
 - Permit any number of readers to hold the lock concurrently
 - Only allow a single writer to hold the lock

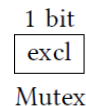

- **Optimistic:**

- Validate that the data read in the critical section has not changed

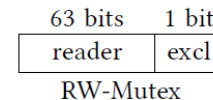

- **Hybrid:**

- Extend a shared lock with support for optimistic locking

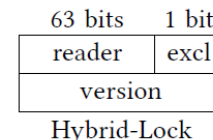
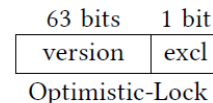

Hybrid locking

```
Class HybridLock {
    RWMutex rwLock;
    std::atomic<uint64_t> version;

    public:
    // simply call rwLock
    void lockShared(); {rwLock.lockShared();}
    void unlockShared(); {rwLock.unlockShared();}
    void lockExclusive(); {rwLock.lockExclusive();}

    // always increment the version before
    // unlocking to avoid races!
    void unlockExclusive() {
        ++version; rwLock.unlockExclusive();}

    bool tryReadOptimistically(Lambda& readCallback) {
        if(rwLock.isLockedExclusive())
            return false;
    }
```

```
    auto preVersion = version.load();
    // execute read callback
    readCallback();
    // was locked meanwhile?
    if(rwLock.isLockedExclusive())
        return false;
    // version still the same
    return preVersion == version.load();
}

void readOptimisticIfPossible(Lambda& readCallback) {
    if(!tryReadOptimistically(readCallback)) {
        // fallback to pessimistic locking
        lockShared();
        readCallback();
        unlockShared();
    }
}
};
```

Evaluating different locks on TPC-C

- Implemented a set of different locks in the HyPer database
- Evaluate their performance using the TPC-C benchmark

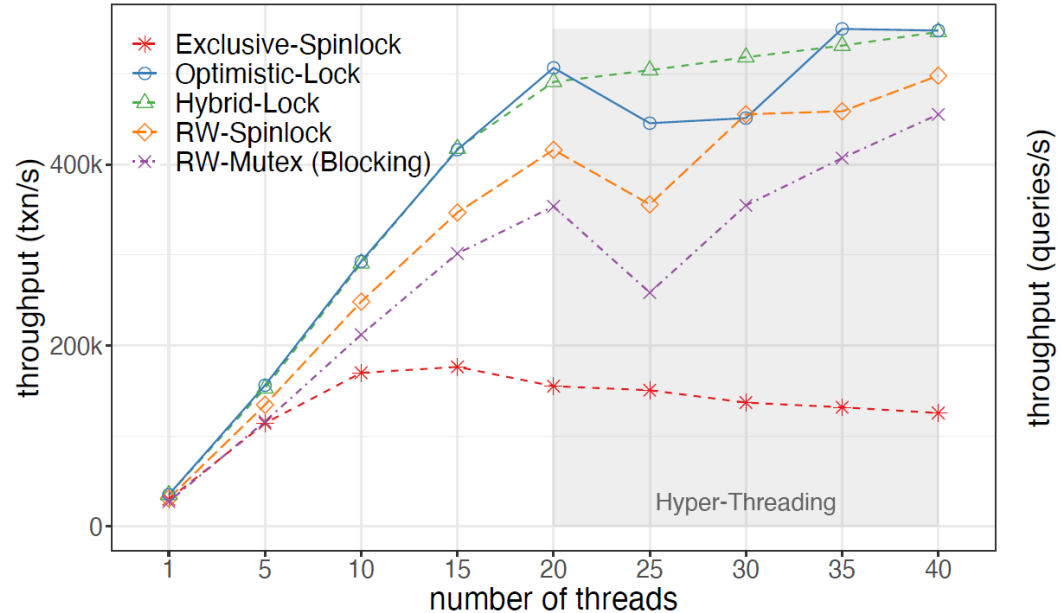

(a) TPC-C – Increasing the number of threads (100 warehouses)

Granularity of locking

- The number of tuples protected by the lock can have a big impact on the system's performance.
- For point accesses like updates and key look-ups, the granularity sets the number of concurrent accesses.
 - Fine granularity is good for write-heavy workloads
 - Coarse granularity is better for read-heavy workloads
 - e.g., no need to acquire a lock for every tuple during a scan

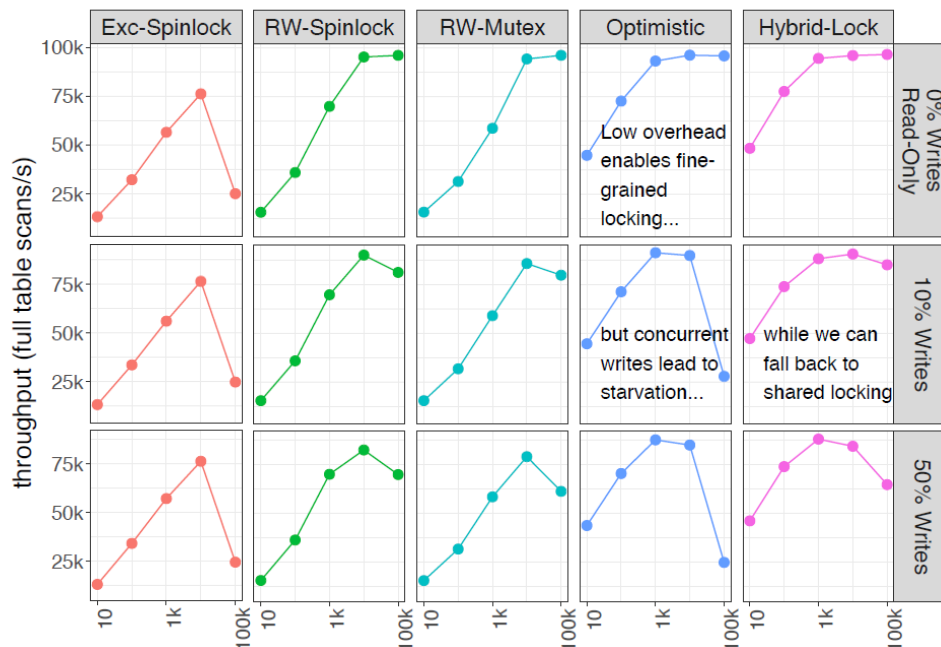

Evaluate contention handling strategies

- How well do different contention handling strategies behave?
- Spinning
 - Naïve (test-and-set)
 - Test-test-and-set (with back-off)
 - Local spinning
 - Ticket-lock (with back-off)
- Blocking
 - `std::mutex`
 - `ParkingLot`
 - Each thread parks itself in a global hashtable (parking lot) until the callback condition is satisfied.

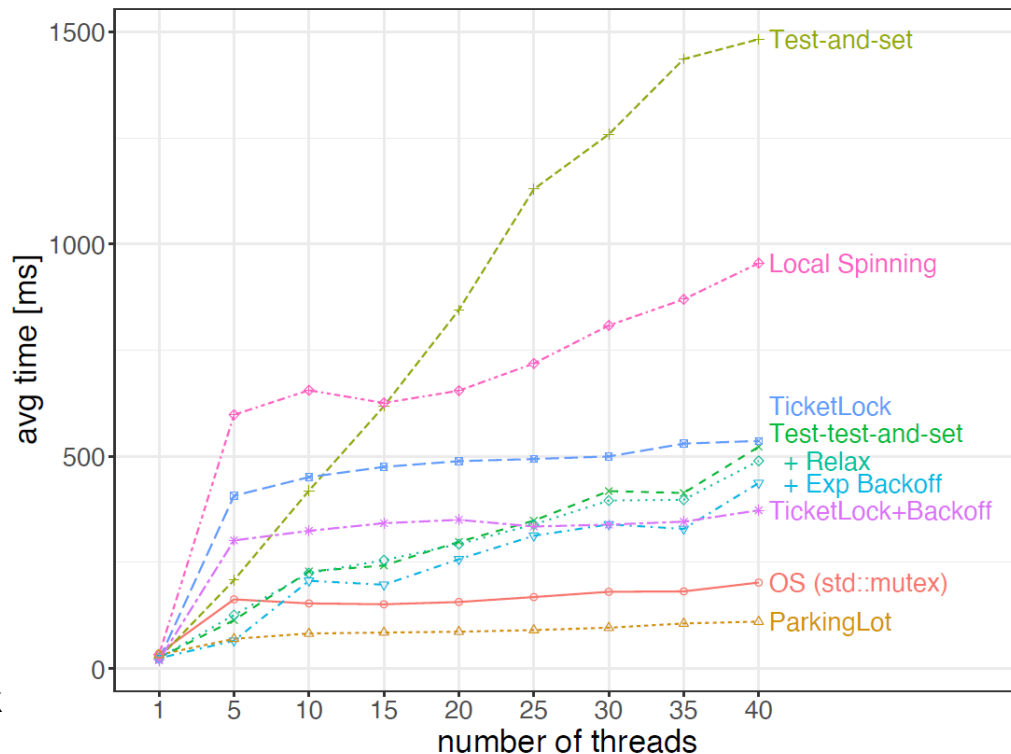

Efficient implementation of concurrent data-structures

Concurrent list-based set

- Operations: `insert(key)`, `remove(key)`, `contains(key)`
- Keys are stored in a (single-)linked list, sorted by key
- `head` and `tail` are always there (“sentinel” elements)

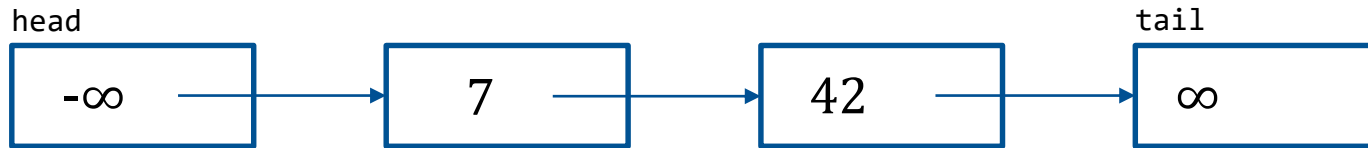

- Why atomics like CAS is sometimes not enough?
 - Thread A: `remove(7)`
 - Thread B: `insert(9)`

Coarse-grained locking

- Use a single lock to protect the entire data structure

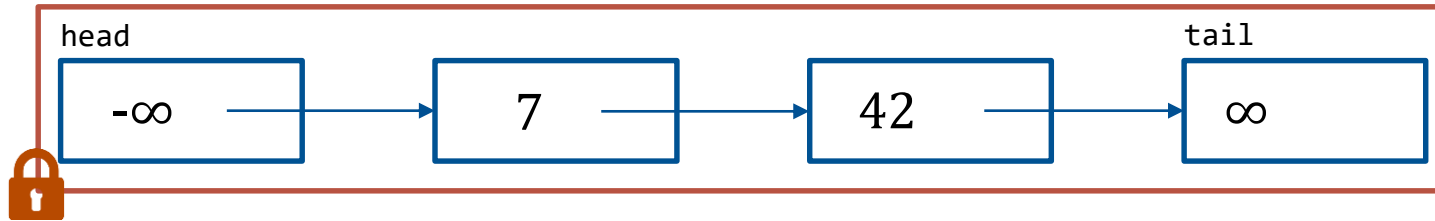

- Positive:
 - Very easy to implement
- Negative:
 - Does not scale at all

Approaches to make it more scalable



■ Fine-grained locking

- Split object into independently synchronized components.
- Conflict when they access the same component at the same time.

■ Optimistic synchronization

- Search without locking.
- If you find it, lock and check. If OK, we are done. If not, start over (can be expensive).

■ Lazy synchronization

- Postpone the hard work
- Removing components: logical removal (mark to be deleted), physical removal (do what's needed).

■ Lock-free synchronization

- Don't use locks at all. Disadvantages: complex and often with high overhead

Fine grained locking with lock coupling

- Also called **hand-over-hand locking** or **crabbing**
- Hold at most two locks at a time
- Interactive lock acquisitions / release pair-wise
- May use read/write locks to allow for concurrent readers

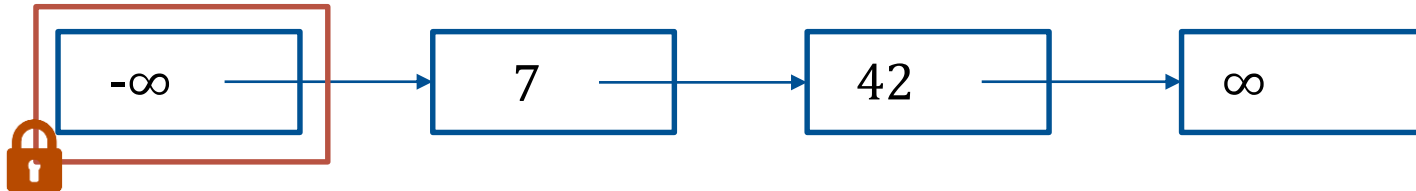

Lock coupling

- Also called “hand-over-hand locking” or “crabbing”
- Hold at most two locks at a time
- Interactive lock acquisitions / release pair-wise
- May use read/write locks to allow for concurrent readers

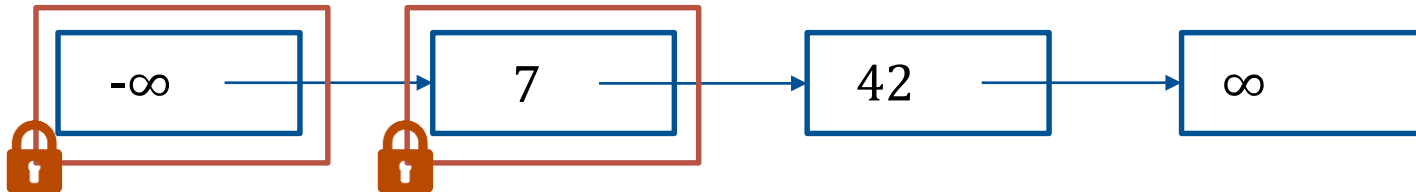

Lock coupling

- Also called “hand-over-hand locking” or “crabbing”
- Hold at most two locks at a time
- Interactive lock acquisitions / release pair-wise
- May use read/write locks to allow for concurrent readers

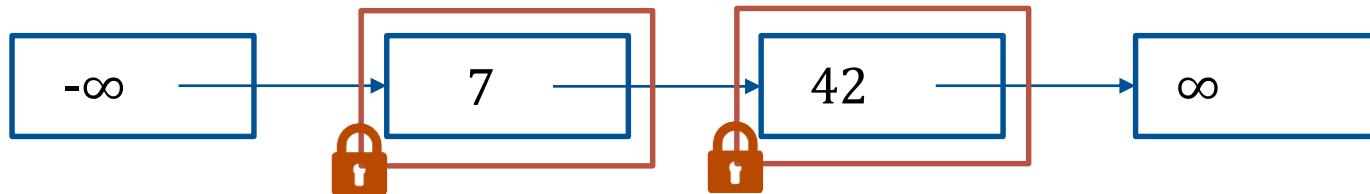

Lock coupling

- Also called “hand-over-hand locking” or “crabbing”
- Hold at most two locks at a time
- Interactive lock acquisitions / release pair-wise
- May use read/write locks to allow for concurrent readers

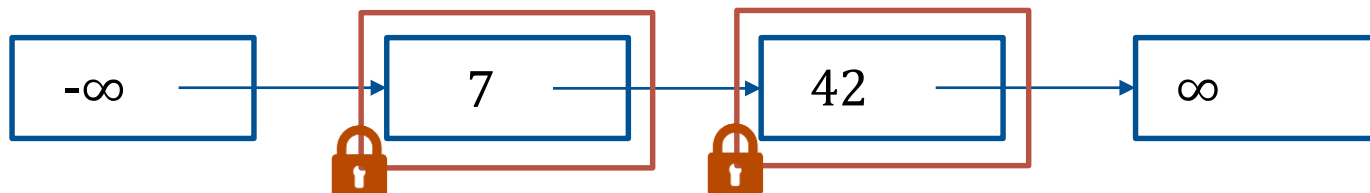

- Positive:
 - Easy to implement
 - No restarts
- Negative:
 - Better than coarse-grained lock (e.g., threads can traverse in parallel), but inefficient.

Optimistic

- Trust, but verify
- Traverse the list optimistically without taking any locks

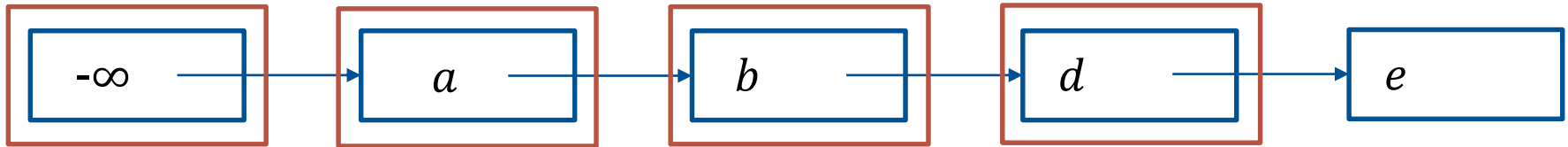

Optimistic

- Trust, but verify
- Traverse the list optimistically without taking any locks
- Lock 2 nodes (predecessor and current)

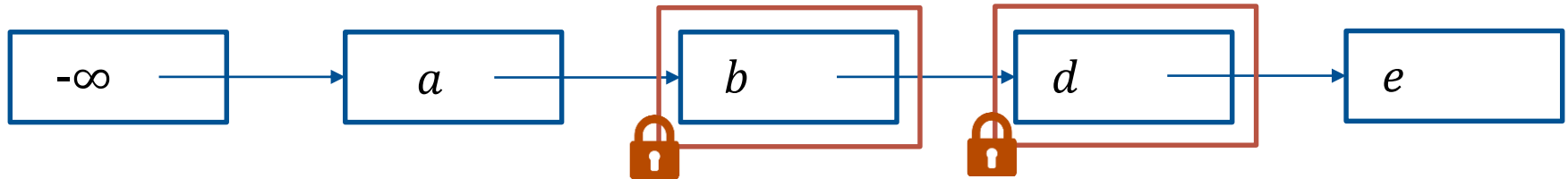

Optimistic

- Trust, but verify
- Traverse the list optimistically without taking any locks
- Lock 2 nodes (predecessor and current)
- Validate: traverse the list again and check that **predecessor is still reachable and points to current**
- If validation fails, unlock and restart

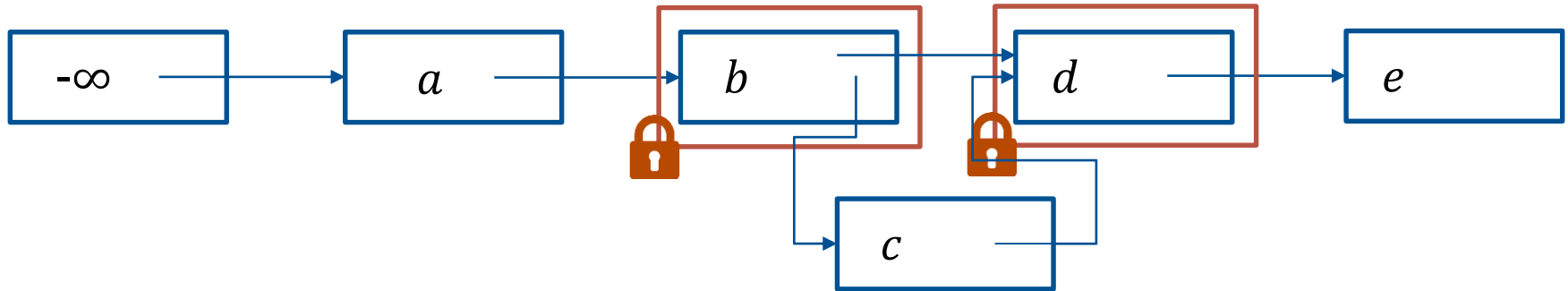

Optimistic

- Trust, but verify
- Traverse the list optimistically without taking any locks
- Lock 2 nodes (predecessor and current)
- Validate: traverse the list again and check that **predecessor is still reachable and points to current**
- If validation fails, unlock and restart

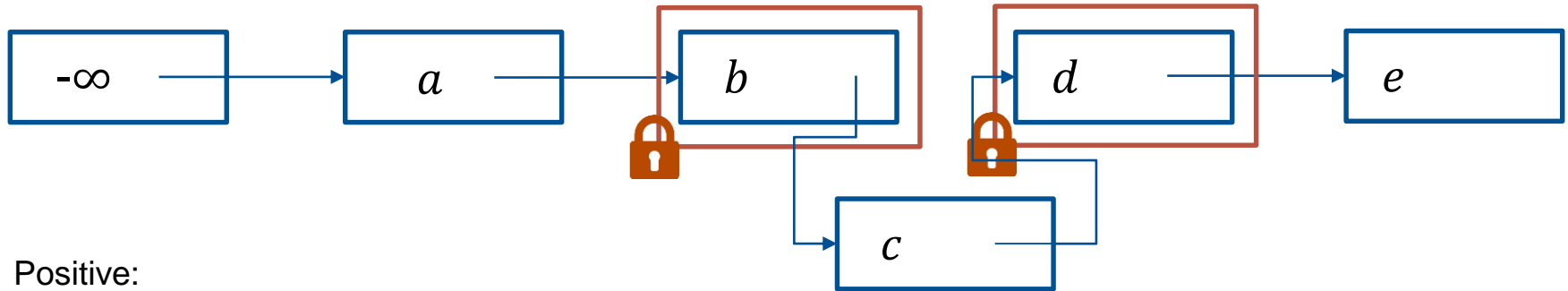

- Positive:
 - Lock contention unlikely
- Negative:
 - Must traverse list twice, method contains acquires a lock

Optimistic lock coupling

- Associate lock with update counter

- Write:
 - Acquire lock (exclude other writes)
 - Increment counter when unlocking
 - Do not acquire locks for nodes that are not modified (traverse like a reader)

- Read:
 - Do not acquire locks, proceed optimistically
 - Detect concurrent modifications through counters (and restart if necessary)

Optimistic lock coupling

- Associate lock with update counter
- Write:
 - Acquire lock (exclude other writes)
 - Increment counter when unlocking
 - Do not acquire locks for nodes that are not modified (traverse like a reader)
- Read:
 - Do not acquire locks, proceed optimistically
 - Detect concurrent modifications through counters (and restart if necessary)
- Positive
 - Easy to implement
 - Scalable
- Negative
 - has restarts

Synchronization in ART tree

- Evaluate the different synchronization approaches (+ lazy (ROWEX), speculative (HTM) and Masstree) on the Adaptive Radix Tree

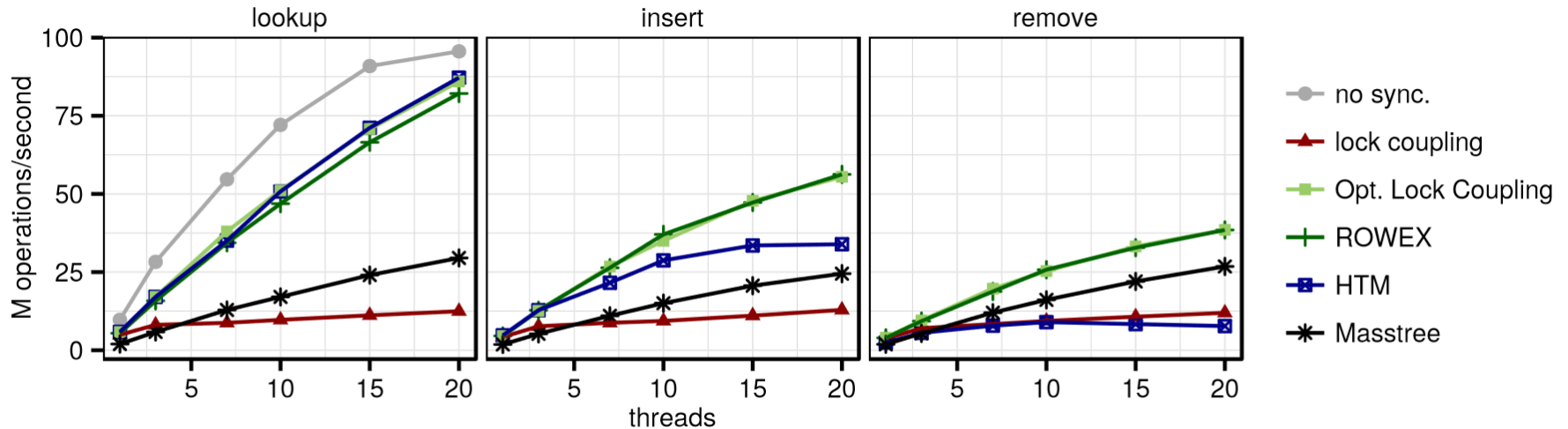

Figure 5: Scalability (50M 8 byte integers)

References

- Various papers cross-referenced in the slides

- Lecture: *Data Processing on Modern Hardware* by Prof. Viktor Leis (Uni Jena, past TUM)
- Lecture: *Data Processing on Modern Hardware* by Prof. Jens Teubner (TU Dortmund, past ETH)
- Lecture: *Supporting Parallelism in OS and Programming Languages* by Dr. Kornilios Kourtis (IBM Research, past ETH)

- Book: *Architecture of a Database System* by Hellerstein, Stonebraker and Hamilton
 - Chapters 2 and 3
- Book: *The Art of Multiprocessor Programming* by Herlihy and Shavit
 - Chapters 7 and 8
- Book: *Is Parallel Programming Hard, And, If So, What Can You Do About It?* by McKenny
- Book: *Computer Architecture: A Quantitative Approach* by Hennessy and Patterson
 - Chapter 5