

Data Processing on Modern Hardware

Jana Giceva

Lecture 6: Data-Level Parallelism (DLP)



Classes of Parallelism and Parallel Architectures



We distinguish two kinds of parallelism in applications:

- **Data-Level parallelism (DLP)**
 - many data items are processed at the same time
- **Task-Level parallelism (TLP)**
 - different tasks operate independently and in parallel

Computer hardware can exploit them in four major ways:

- **Instruction-level parallelism (ILP)** – exploits DLP using pipelining and speculative execution
- **Vector architectures**, SIMD, GPUs – exploit DLP by applying the same instructions to a collection of data
- **Thread-level parallelism** – exploit DLP and/or TLP using hardware threads that work in parallel
- **Request-level parallelism** – exploits DLP and TLP using mainly de-coupled tasks specified by the programmer (usually at large scale, think data-center)

- **SISD – Single instruction stream, single data stream**
 - Standard sequential computer, that can exploit ILP (last week's lecture)
 - Example: uni-processor
- **SIMD – Single instruction stream, multiple data streams**
 - The same instruction is executed by multiple processors or special instruction sets using potentially multiple data streams
 - Example: vector, SIMD extensions to standard ISAs, GPUs
- **MISD – Multiple instruction streams, single data stream**
- **MIMD – Multiple instruction streams, multiple data streams**
 - Each processor fetches its own instructions and operates on its own data, targets TLP
 - Example: multi-socket, multicore machines (thread-level parallelism) or rack- / warehouse-scale computers (request-level parallelism)

Vector Processors (and SIMD extensions)

Most modern processors include a **SIMD** unit.

- Single Instruction stream, Multiple Data streams

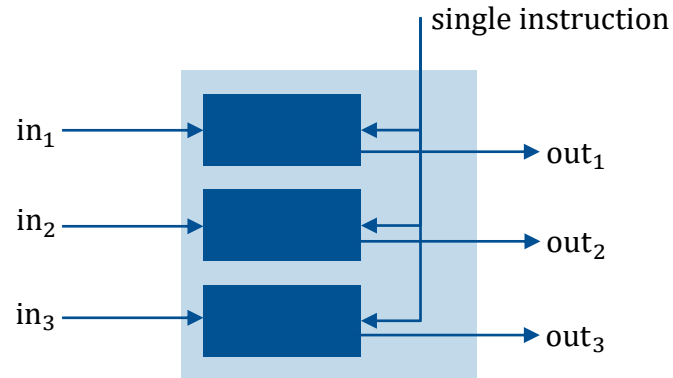

- Execute the same assembly instructions on a set of values.
- Also called **vector unit**; **vector processors** are entire systems built on that idea.

- **Vector registers**
- Vector **functional units**
- Vector **load / store units**
- Set of **scalar registers**
 - Provide data as input to vector functional units
 - Compute addresses to pass to the vector load/store units
- Can **program** the vector processor with **vector instructions** – apply the same operation on vectors of data
- When the compiler produces vector instructions, and the resulting code spends much of its time running in vector mode, the code is said to be **vectorized**
 - Loops can be vectorized when they do not have dependencies between the iterations

- **MultiMedia Extensions (MMX)** (1996) repurposed existing 64-bit floating point registers
- **Streaming SIMD Extensions (SSE)** (1999) introduced 16 x 128-bit wide registers (XMM)
- **Advanced Vector Extensions (AVX)** (2010) new 16 x 256-bit wide registers (YMM)
 - vaddpd, vsubpd, vmulpd, vdivpd, vfmaddpd, vfmsubpd, vmpxx, vmovapd, vbroadcastsd
- **AVX2** (2013) added 30 new instructions
 - e.g., gather (vgather) and vector shifts (vpsll, vpsrl, vpsra)
- **AVX-512** (2017) doubled the width to 512 bits (32 x ZMM registers) and added 250 new instructions
 - e.g., scatter (vpscat) and mask registers (opmask)

- The goal of these extensions are to **accelerate** carefully written **libraries** rather than for the compiler to generate them

- Recent **x86 compilers** try to **generate** such **code** for **floating point intensive applications**

- Since the opcode determines the width of the SIMD register, every time the width doubles so must the number of SIMD instructions

SIMD Programming Model

The processing model is typically based on **SIMD registers** or **vectors**.

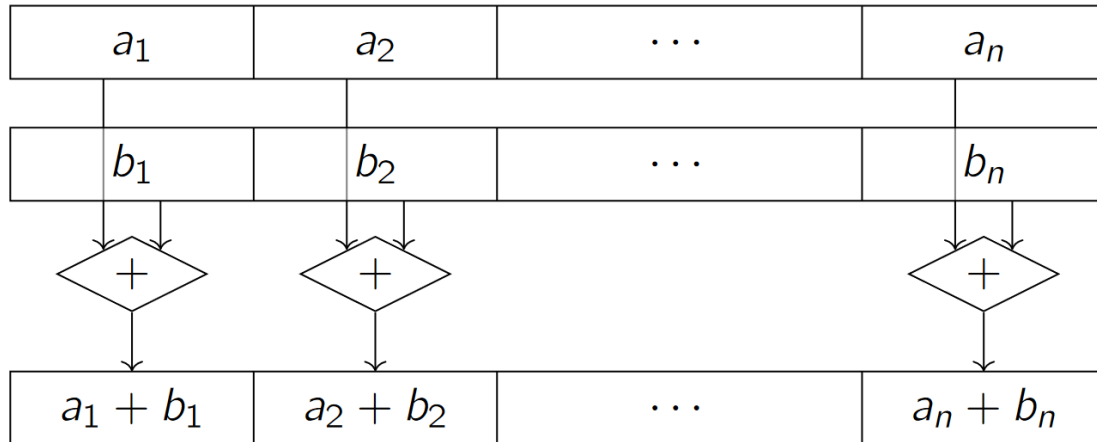

Typical values (e.g., on Intel Skylake):

- 32 × 512 bit-wide registers (zmm0 through zmm31)
- Usable as 64 × 8-bit integers, 32 × 16-bit integers, 16 × 32-bit integers, 8 × 64-bit integers, 16 × 32-bit floats, or 8 × 64-bit floats

SIMD Programming Model



- SIMD instructions make **independence** explicit
 - No data hazards within a vector instruction
 - Check for data hazards only between vectors.
 - **Data parallelism**
- Data **may** need to be **aligned** in memory to the **width** of the SIMD unit to prevent the compiler generating scalar instructions for otherwise vectorizable code.
- Parallel execution promises n-fold performance advantage
 - Not quite achievable in practice, however.
- Vector code sometimes uses more instructions on trivial things:
 - Converting and moving data to the right position in the register
 - Emulating branches with conditional moves

How can I make use of SIMD instructions as a programmer?

■ Auto-vectorization

- Some compilers automatically detect opportunities to use SIMD
- Approach is rather limited, do not rely on it (check with `objdump` or `godbolt.org`)
- Advantage: platform independent

■ Compiler attributes

- Use `__attribute__((vector_size (...)))` annotations to state your intentions
- Advantage: platform independent
- Compiler will generate non-SIMD code if the platform does not support it

Auto-vectorization example

```
#include <stdlib.h>
#include <stdio.h>
int main (int argc, char **argv){
    int a[256], b[256], c[256];
    for(unsigned int i = 0; i < 256; i++){
        a[i] = i + 1;
        b[i] = 100 * (i + 1);
    }
    for(unsigned int i = 0; i < 256; i++) {
        c[i] = a[i] + b[i];
    }
    printf("c = [ %i, %i, %i, %i ]\n",
           c[0], c[1], c[2], c[3]);
    return EXIT_SUCCESS;
}
```



- Using x86-64 gcc 10.1 (flag -O3)
 - movdqa – move aligned packed integer value
 - paddb – parallel add packed integers (d stands for 32-bit values)
 - movaps – move aligned packed single precision FP value

```
.L3:
    movdqa 1040(%rsp,%rax), %xmm5
    movdqa 16(%rsp,%rax), %xmm0
    paddb  %xmm5, %xmm0
    movaps %xmm5, (%rsp)
    movaps %xmm0, 2064(%rsp,%rax)
    addq   $16, %rax
    cmpq  $1024, %rax
    jne   .L3
```

Register	Use
%rax	i
%xmm5	b[i]
%xmm0	a[i], c[i]

Increment i by SIMD length of 16 bytes, and check the loop condition.

Compiler attribute

```
#include <stdlib.h>
#include <stdio.h>
typedef int v4si __attribute__((vector_size (
16)));
union int_vec {int val[4];v4si vec;};

typedef union int_vec int_vec;
int main (int argc, char **argv){
    int_vec a, b, c;
    a.val[0] = 1; a.val[1] = 2;
    a.val[2] = 3; a.val[3] = 4;
    b.val[0] = 100; b.val[1] = 200;
    b.val[2] = 300; b.val[3] = 400;
    c.vec = a.vec + b.vec;
    printf ("c = [ %i, %i, %i, %i ]\n",
            c.val[0], c.val[1], c.val[2], c.val[3]);
    return EXIT_SUCCESS;
}
```



- Using x86-64 gcc 10.1 (flag -O0)
 - Data transfers scalar ↔ SIMD is done through memory

```
movl $1, -16(%rbp)
movl $2, -12(%rbp)
movl $3, -8(%rbp)
movl $4, -4(%rbp)
movl $100, -32(%rbp)
movl $200, -28(%rbp)
movl $300, -24(%rbp)
movl $400, -20(%rbp)
movdqa -16(%rbp), %xmm1
movdqa -32(%rbp), %xmm0
padd %xmm1, %xmm0
movaps %xmm0, -48(%rbp)
```

Register	Use
%xmm0	b, c
%xmm1	a

Coding for SIMD - intrinsics

- Use the SIMD registers explicitly using **intrinsics**, without having to write assembly code
- **Advantages:**
 - As a programmer, you have good control over the instructions that are generated
 - The compiler will manage the register allocation (better than hand-written assembly)
- **Disadvantages:**
 - Code no longer portable to different architectures or you need to provide alternative code for non-SIMD processing
 - If not done carefully, automatic glue code (e.g., cast, etc.) may make the code inefficient.
 - Code readability decreases

```
#include <stdlib.h>
#include <stdio.h>
#include <xmmintrin.h>
int main (int argc, char **argv){
    __m128i x, y;
    a[0] = 1; a[1] = 2; a[2] = 3; a[3] = 4;
    b[0] = 100; b[1] = 200; b[2] = 300; b[3] = 400;
    x = _mm_loadu_si128 ((__m128i *) a);
    y = _mm_loadu_si128 ((__m128i *) b);
    x = _mm_add_epi32 (x, y);
    _mm_storeu_si128 ((__m128i *) c, x);
    printf ("c = [ %i, %i, %i, %i ]\n",
           c[0], c[1], c[2], c[3]);

    return EXIT_SUCCESS;
}
```

- **Intrinsics:** compilers wrap up asm instructions as functions
 - Can use them by calling a function with the right parameters
 - `<vector_size>_<intrin_op>_<suffix>`
 - `<vector_size>`: mm for 128-bit, mm256 and mm512
 - `<intrin_op>`: add, sub, mul, etc.
 - `<suffix>`: ps (float), pd (double), epi32 (signed int), epu16 (unsigned 16-bit integer), etc.
- **Example** with AVX 128-bit intrinsics
 - `__m128i` ← XMM register for all integer types
 - `_mm_loadu_si128` ← load (unaligned) 128-bits from memory
 - corresponds to `vmovdqu` assembler instruction
 - `_mm_add_epi32` ← vector add four signed 32-bit integers
 - corresponds to `vpaddd` assembler instruction
 - `_mm_storeu_si128` ← store (unaligned) 128-bits to memory

Exploiting SIMD for data processing and databases

Working with masks

- Conditional execution of vector elements
- Starting from AVX-512 almost all operations support masking

Zero Masking (selectively ignore some of the SIMD lanes)

- Example: add elements, but set those not selected by mask to zero:
 - vector `add_vector_mask` (mask k, vector a, vector b)
 - `__m512i _mm512_maskz_add_epi32 (__mask16 k, __m512i a, __m512i b)`

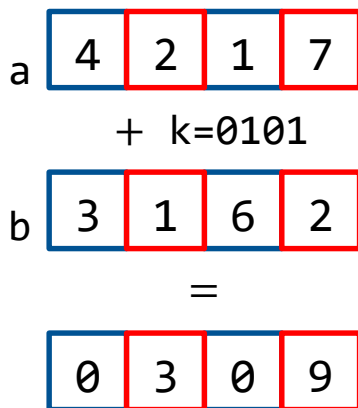

Masking with Merging / Blending

- Blend only instruction
 - vector `blend_vector_mask(mask k, vector a, vector b)`
 - `__m512i __mm512_mask_blend_epi32 (__mmask16 k, __m512i a, __m512i b)`
- Blend new result with previous result (“merge”)
 - vector `add_vector_mask (vector src, mask k, vector a, vector b)`
 - `__m512i __mm512_mask_add_epi32 (__m512i src, __mmask16 k, __m512i a, __m512i b)`

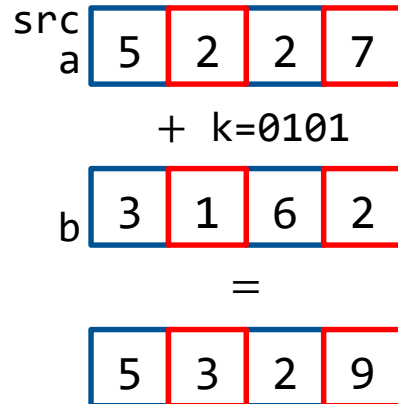

Note the difference between mask and maskz from previous slide.

Working with masks

Compress and expand

- Compress: `__m512i _mm512_maskz_compress_epi32(__mmask16 k, __m512i a)`
 - Also to memory: `compressstoreu`
- Expand: `__m512i _mm512_maskz_expand_epi32(__mmask16 k, __m512i a)`
 - Also to memory: `expandloadu`

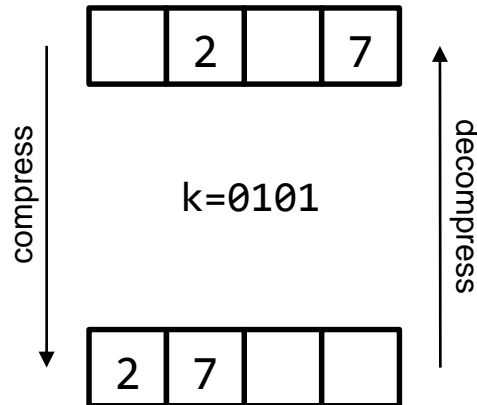

Fundamental operations

■ Selective store

- Write a specific subset of the vector to a memory location contiguously. The subset is determined using vector/scalar register as the mask.

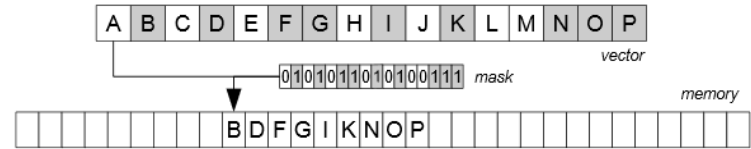

■ Selective load

- Loading from a memory location contiguously to a subset of vector lanes based on a mask. The lanes that are inactive in the mask, retain the old values.

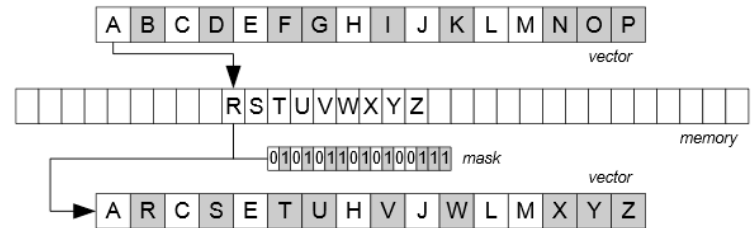

■ Gather operation

- Load values from non-contiguous location.

■ Scatter operation

- Scatter executes stores to multiple locations.

Gather and scatter are not executed in parallel because the cache allows limited distinct accesses per cycle.

SIMD naturally fits a number of scan-based database tasks:

- Arithmetics

```
SELECT price + tax AS net_price  
FROM orders
```

This is what the code examples in the previous slide (10-13) were doing.

- Aggregation

```
SELECT MIN(quantity)  
FROM lineitem
```

- How can this be done efficiently?
 - Similarly for `sum(·)`, `max(·)`, `count(·)`, etc.

Selection

Selection queries are slightly more tricky:

- There are **no branching primitives** for SIMD registers
 - What would the semantics be anyhow?
- **Moving data** between SIMD and scalar registers is quite expensive
 - Either **go through memory**, move one data item at a time
 - Or **extract sign mask** from SIMD registers

```
SELECT quantity
FROM   lineitem
WHERE  price > 42
```

Selection example

```
uint32_t scalar_sel(int32_t* in, int32_t count, int32_t val, int32_t* out){
    uint32_t out_pos = 0;
    for (int32_t i=0; i < count; i++)
        out[out_pos] = in[i];
        out_pos += (in[i] < val);
    return out_pos;
}
```

```
uint32_t vector_sel(int32_t* in, int32_t count, int32_t val, int32_t* out){
    uint32_t out_pos = 0;
    vector cmp = load_vector(val);
    for (int32_t i=0; i < count; i+=16) {
        vector inV = load_vector(in+i);
        mask mask = compare_vector(inV, cmp);
        compress_store(out+out_pos, mask, inV);
        uint32_t count = count_vector(mask);
        out_pos += count;
    }
    return out_pos;
}
```

Use-case: Tree-search

- In-memory tree look-ups
- Base case: **binary tree**, scalar implementation

```
for (unsigned int i=0; i<n_items; i++) {  
    k = 1; /* tree[1] is root node */  
    for (unsigned int lvl=0; lvl<height; lvl++)  
        k=2*k+(item[i]<=tree[k]);  
    result[i]=data[k];  
}
```

- Represent binary tree as an array `tree[.]` such that children of n are at positions $2n$ and $2n + 1$
- **Q1: Can we vectorize the outer loop?** (find matches for four input items in parallel)
 - Iterations of the outer loop are independent, there is no branch in the loop body
 - Need to use the scatter/gather instructions.
- **Q2: Can we vectorize the inner loop?**
 - Data dependency between loop iterations (variable k)
 - Can speculatively navigate levels ahead.

“Speculative” Tree Navigation

Idea: Do comparisons for two levels in parallel

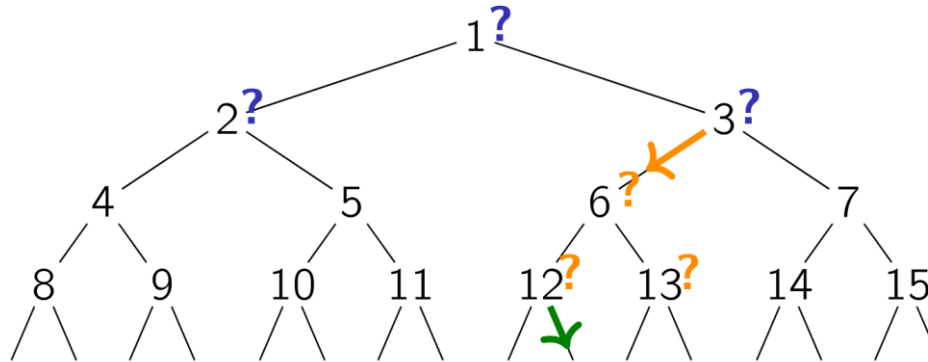

- Compare with nodes 1, 2 and 3 in parallel
- Follow link to node 6 and compare with nodes 6, 12 and 13
- etc.

SIMD Blocking

- Pack tree sub-regions into SIMD registers

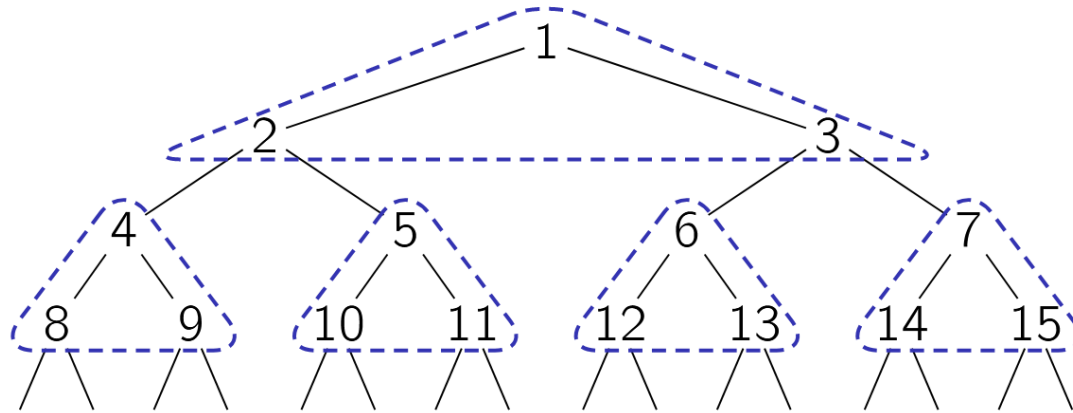

- Re-arrange data in memory for this.

SIMD and scalar registers

e.g., search key 59

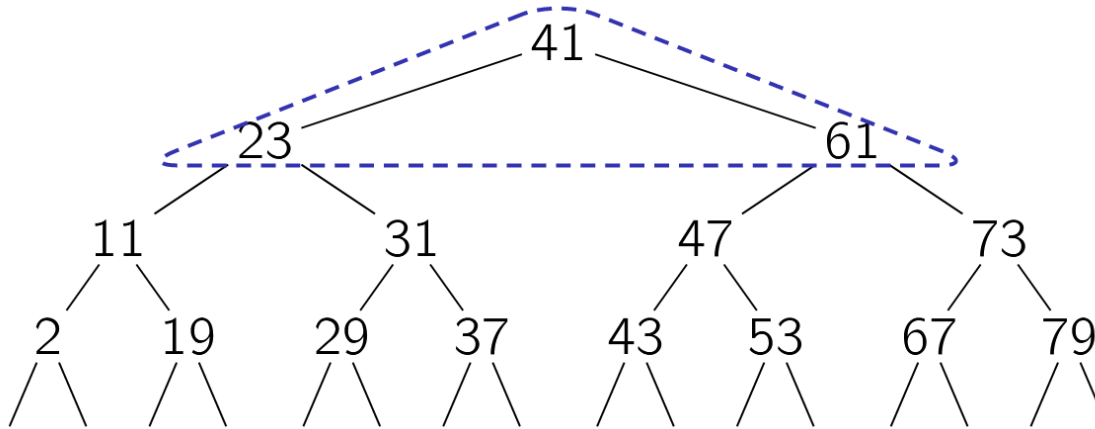

- SIMD to compare, scalar to navigate, movemask in-between

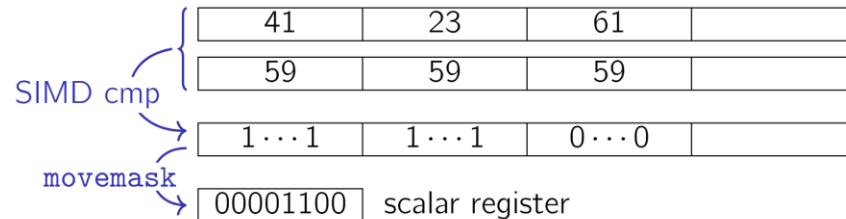

Tree Navigation

Use mask value as **index** in **lookup table**.

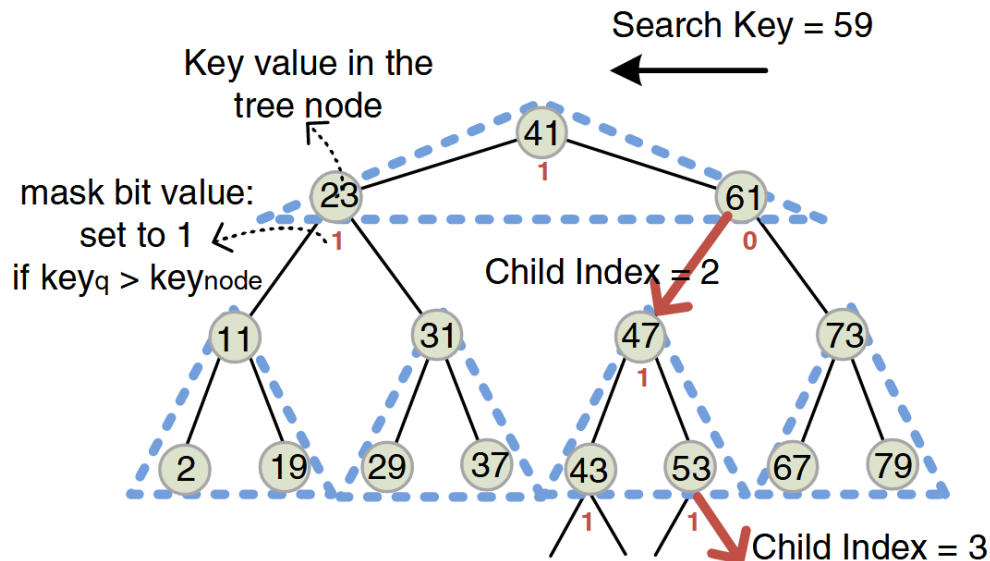

Use mask value as index

Lookup Index	Child Index
000	0
100	N/A
010	1
110	2
001	N/A
101	N/A
011	N/A
111	3

Lookup Index Child Index

Hierarchical Blocking

- **Blocking** is a good idea also beyond SIMD

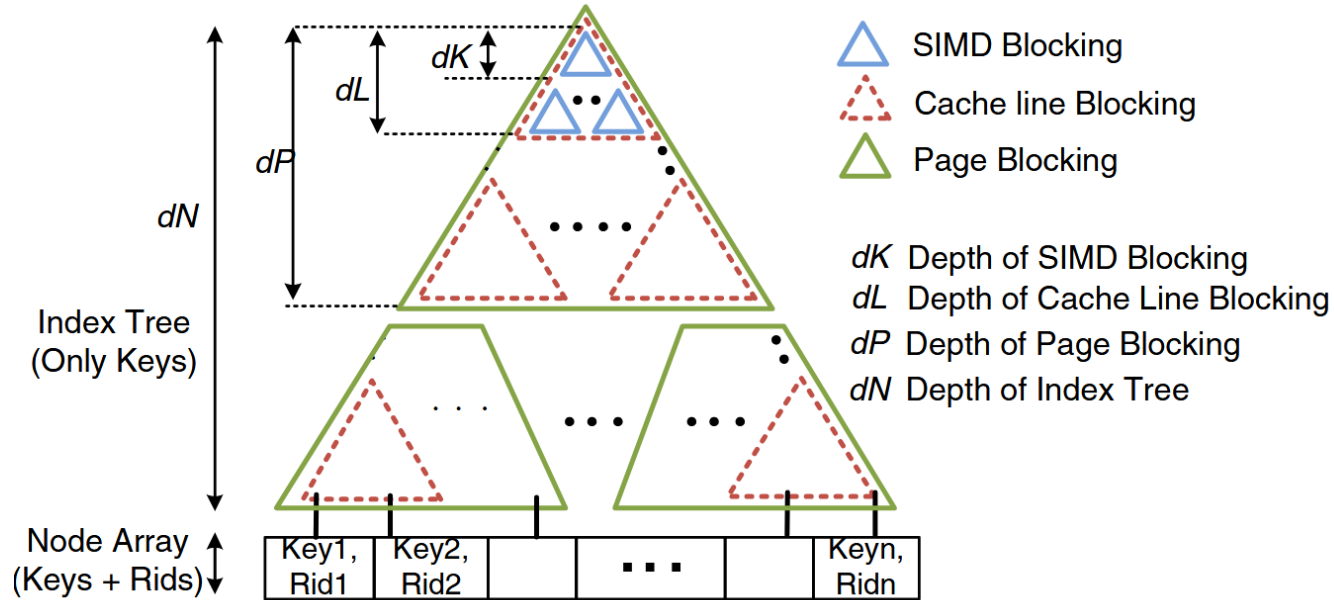

SIMD Tree Search: Performance

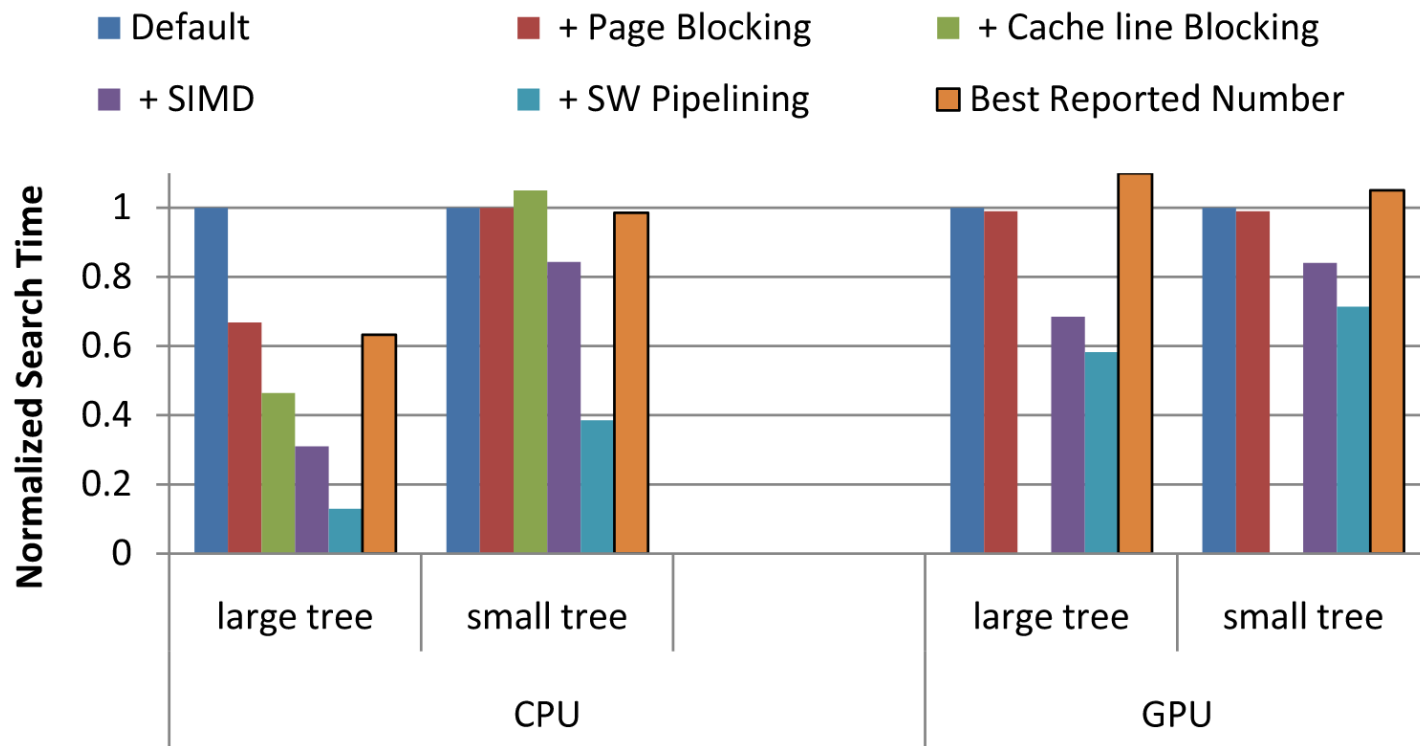

Small tree – 64k keys
Large tree – 64M keys
Corei7 CPU with total
12.8 GHz frequency

Use case: Decompression

- Light-weight compressions schemes (e.g., numeric compression (NC), string compression (SC), dictionary compression (DC), etc.) is a good candidate for vectorized decompression.
- LWC NC is based on null suppression and encoding the resulting length of the compressed integer.
 - The integer value “ 3_d ” can be stored by storing only “ 11_b ” and ignoring the other thirty “ 0_b ” bits.

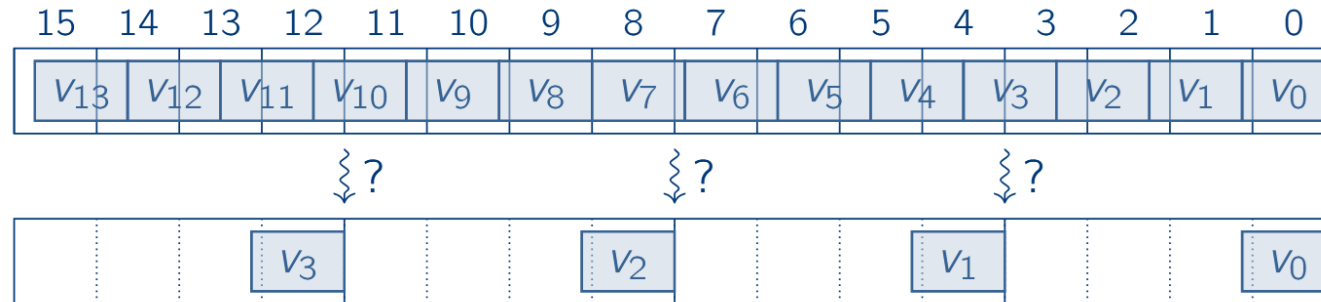

Decompression – Step 1: Copy Values

Step 1: Bring data into proper 32-bit words.

- For this example we assume 128-bit wide SIMD registers (but, the method generalizes).

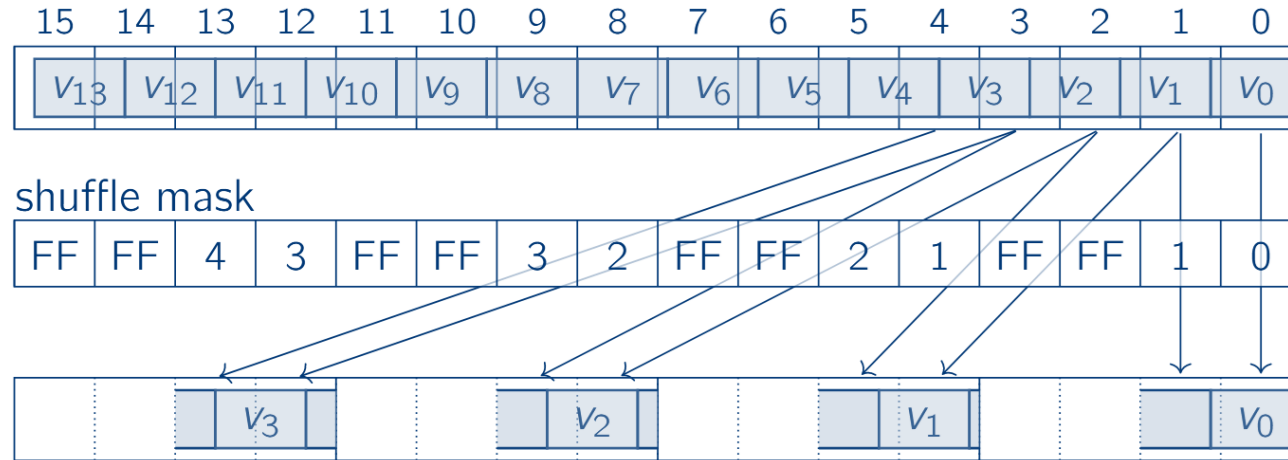

- Use **shuffle instructions** and a **mask** to move **bytes** within SIMD registers

Decompression – Step 2: Establish Same Bit Alignment

Step 2: Make all four words identically bit-aligned.

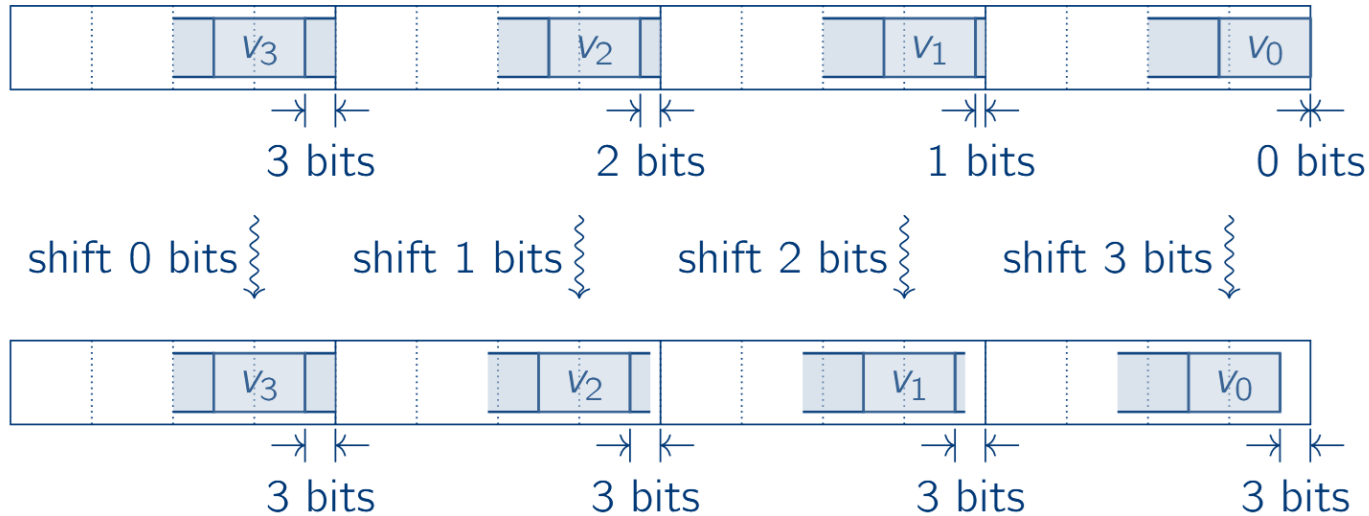

- Need a 32-bit SIMD shift instruction with 4 variable shift amounts
- As 128-bit SIMD shift with variable amount is not supported

Decompression – Step 3: Shift and Mask

Step 3: Word-aligned data and mask out invalid bits.

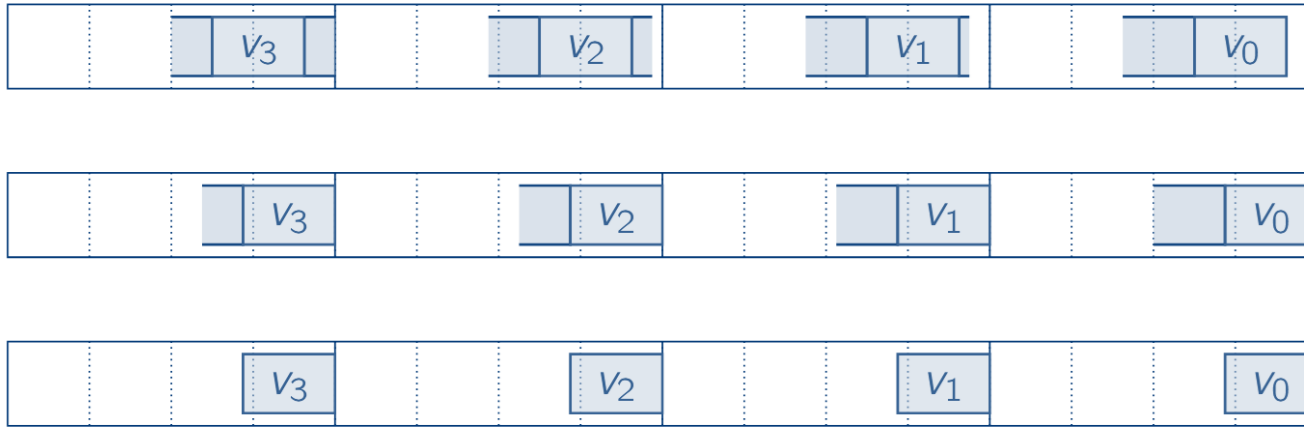

- Shift right for 3 bits to make it 32-bit aligned:
 - `__m128i shifted = _mm_srli_epi32(in, 3);`
- Mask out the invalid bits:
 - `__m128i result = _mm_si128(shifted, maskval);`

Decompression -- Performance

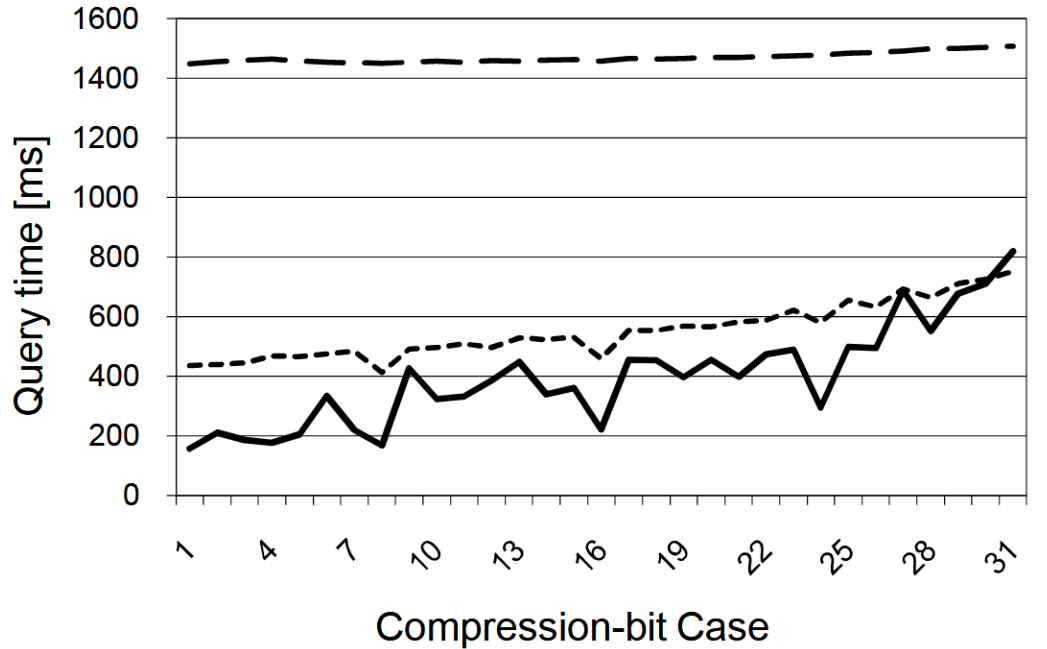

Time to decompress 1 billion integers on Xeon X5560, 2.8 GHz

Optimized scalar – minimized cache miss rate and massive loop unrolling.

8/16/24-bit compressed data has better performance

— unoptimized scalar -.- optimized scalar — vectorized

Decompression and predicate evaluation

- Sometimes it may be sufficient to decompress only partially.
- e.g., selection queries on compressed data

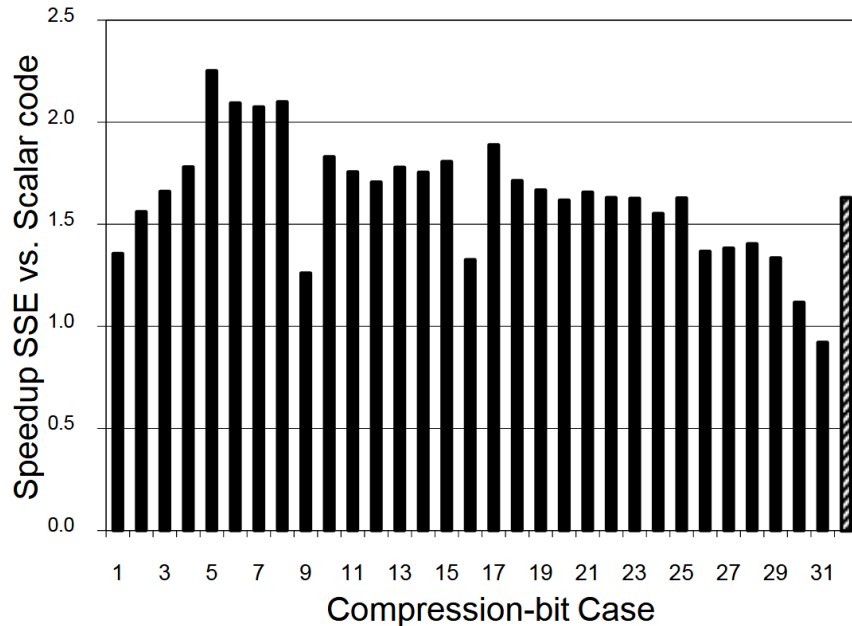

Performance is higher for the bit cases up to 8-bits, where 8 values can be processed in parallel with one SSE register.

Use case: sort

Merge-sort can benefit from SIMD acceleration

- Block 1: run generation
- Block 2: merging of pre-sorted runs

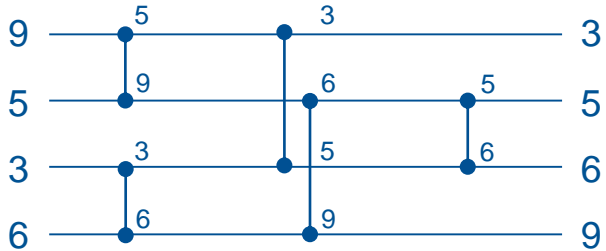

Odd-even sorting network for four inputs

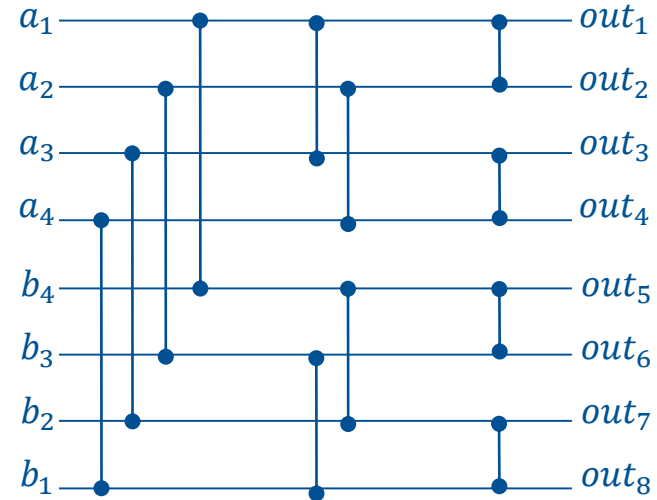

Bitonic merge network

Sort – sorting network

- The comparators can be implemented using min/max
 - Input variables a , b , c , and d
 - Output variables w , x , y , and z

```
e = min(a, b)    j = min(f, h)
f = max(a, b)    w = min(e, g)
g = min(c, d)    x = min(i, j)
h = max(c, d)    y = max(i, j)
i = max(e, g)    z = max(f, h)
```

- This will sort input items across SIMD registers, but not within a vector
- Before writing back to memory, SIMD register must be **transposed** (i.e., w_2 must be swapped with x_1 , w_3 with y_1 , etc.) with SIMD shuffle

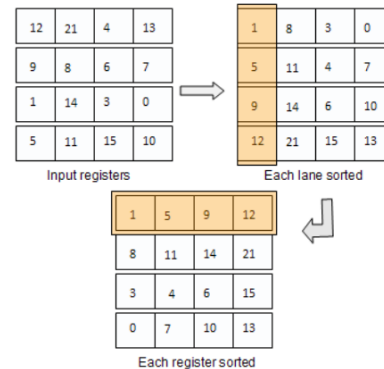

Sort – bitonic merge network

- **Idea:** larger networks can be built with help of merging networks that combine two pre-sorted inputs
- Each comparator stage can be implemented using one max and one min SIMD instruction
- Shuffle instructions in-between the three stages bring vector elements into their proper positions

```
// A and B are input registers
B = shuffle_vector(B, B, imm1) - reverses vector B
L1 = min_vector(A, B)
H1 = max_vector(A, B) - L1 comparisons
L1p = shuffle_vector(L1, H1, imm2)
H1p = shuffle_vector(L1, H1, imm3) - L1 shuffles
L2 = min_vector(L1p, H1p)
H2 = max_vector(L1p, H1p) - L2 comparisons
L2p = shuffle_vector(L2, H2, imm4)
H2p = shuffle_vector(L2, H2, imm5) - L2 shuffles
L3 = min_vector(L2p, H2p)
H3 = max_vector(L2p, H2p) - L3 comparisons
L3p = shuffle_vector(L3, H3, imm6)
H3p = shuffle_vector(L3, H3, imm7) - L3 shuffles
```

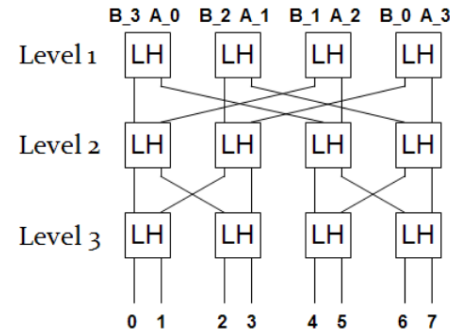

The exact number of shuffles depends on the bit-width of the input items and the size of the registers (AVX, AVX-512)

Multi-way merge

Cache-conscious sort-merge

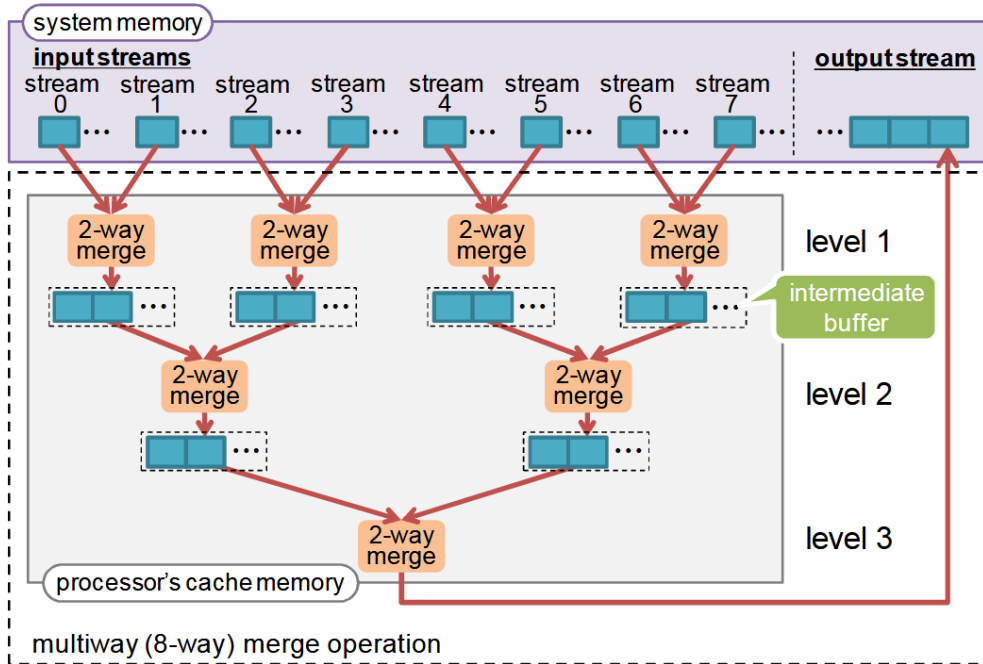

Multi-way merge sort the number of merge stages from $\log_2 N$ to $\log_k N$, where k is the number of ways, and N is the total number of records to sort.

Sort – results

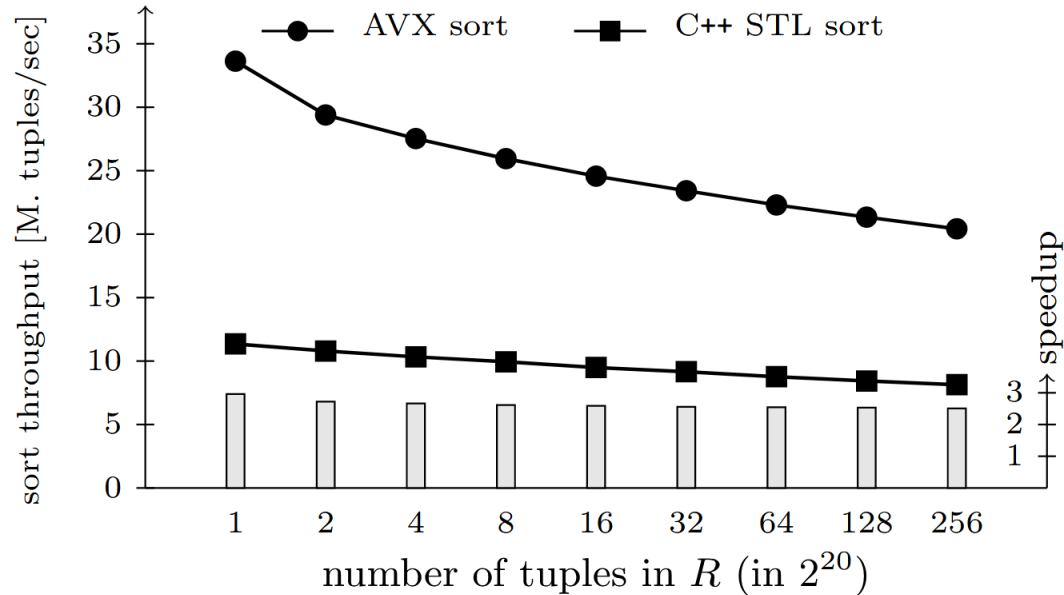

1 thread, input table from 8MB to 2GB
Machine: Intel SandyBridge with 256-bit
AVX instructions.

- Various papers cross-referenced in the slides
 - Kim et al. *FAST: Fast Architecture Sensitive Tree Search on Modern CPUs and GPUs*. SIGMOD 2010
 - Willhalm et al. *SIMD-Scan: Ultra Fast In-Memory Table Scan using on-Chip Vector Processing Units*. VLDB 2009
 - Chhugani et al. *Efficient Implementation of Sorting on Multi-core SIMD CPU Architectures*. VLDB 2008
 - Balkesen et al. *Multi-core, Main-memory joins: sort vs. hash revisited*. VLDB 2014
 - Polychroniou and Ross. *Rethinking SIMD Vectorization for In-Memory Databases*. SIGMOD 2015
 - Polychroniou and Ross. *Efficient Lightweight Compression Alongside Fast Scans*. DaMoN 2015
 - Inoue and Taura. *SIMD- and Cache-friendly Algorithm for Sorting an Array of Structures*. VLDB 2016
- Lecture: *Data Processing on Modern Hardware* by Prof. Jens Teubner (TU Dortmund, past ETH)
- Lecture: *Data Processing in Modern Hardware* by Prof. Viktor Leis (FAU Erlangen-Nuernberg, past Uni Jena, TUM)
- Book: *Computer Architecture: A Quantitative Approach* by Hennessy and Patterson
 - Chapter 4 and Appendix H
- Book: *An optimization guide for x86 platforms* by Agner Fog (TU Denmark).
 - Chapter 2: Optimizing sub-routines in assembly Language, Section 13: Vector Programming
- Intel 64 and IA-32 Architectures Software Developer's Manual
 - Chapter 15 (Programming with Intel AVX-512)
- AMD64 Architecture Programmer's Manual
- Check out the generated code from the compiler on various machines with godbolt.org
 - Compile the code with the appropriate flag `-march=skylake-avx512 -O3`

Appendix – source code examples

Intrinsics – Data Types



- ZMM registers are represented as special data types:
 - `__m512i` (all integer types, width is specified by operations)
 - `__m512` (32-bit floats)
 - `__m512d` (64-bit floats)
- Operations look like C functions, e.g., add 16 32-bit integers
 - `__m512i _mm512_add_epi32(__m512i a, __m512i b);`
- Compiler does the register allocation

Loading / storing data to / from registers

- **aligned load** memory location has to be 64-byte aligned):
 - `__m512i _mm512_load_si512 (void const* mem_addr)`
- **unaligned load** (slightly slower):
 - `__m512i _mm512_loadu_si512 (void const* mem_addr)`
- **broadcast** a single value (available for different widths):
 - `__m512i _mm512_set1_epi32(int a)`
- There is no instruction for loading a 64-byte constant into a register (must happen through memory); but, there is a convenient (but slow) intrinsic for that:
 - `__m512i _mmset_epi32(int e15, ..., int e0)`
- **store**:
 - `void _mm512_store_epi32 (void* mem_addr, __m512i a);`

Arithmetic Operations

- Addition / subtraction: `add`, `sub`
 - Multiplication (truncated): `mullo` (16, 32, or 64 bit input, output size same as input)
 - Saturated addition / subtraction: `adds`, `subs` (stays at extremum instead of wrapping, only 8 and 16 bits)
 - Absolute value: `abs`
 - Extrema: `min` / `max`
 - Multiplication (full precision): `mul` (only 32-bit input, produces 64-bit output)
 - Some of these are also available as unsigned variants (epu suffix)
-
- No integer division / modulo (division by 2 can be emulated using shift)
 - No overflow detection

```
alignas(64) int in[1024];
void simpleMultiplication(){
    __m512i three = _mm512_set1_epi32(3);
    for (int i=0; i<1024; i+=16){
        __m512i x = _mm512_load_si512(in + i);
        __m512i y = _mm512_mullo_epi32(x, three);
        _mm512_store_epi32(in + i, y);
    }
}
```

Logical and Bitwise Operations



- Logical: `and`, `andnot`, `or`, `xor`
- Rotate left (right) by some value: `rol` (`ror`)
- Rotate left (right) by different value: `rolv` (`rorv`)
- Shift left (right) by same value: `slli` (`srl`)
- Shift left (right) by different value: `sllv` (`srlv`)
- Convert different sizes (zero/sign-extend, truncate): `cvt`
 - 32 to 64: `__m512i _mm512_cvtepi32_epi64 (__m256i a)` (sign extend)
 - 32 to 64: `__m512i _mm512_cvtepu32_epi64(__m256i a)` (zero extend)
 - 64 to 32: `__m256i _mm512_cvtepi64_epi32 (__m512i a)` (truncate)
- Count leading zeros: `lzcnt`

- Compare 32-bit integers:
 - `__mmask16 __mm512_cmpOP_epi32_mask (__m512i a, __m512i b);`
 - OP is one of (eq, ge, gt, le, lt, neq)
- Comparisons may also taken a mask as input, which is equivalent to performing AND on the masks
- Assumes signed integers
 - to compare unsigned integers, flip the most significant bit of inputs using xor
- Result is a bitmap stored in a special “opmask” register (K1-K7) and is available as special data type (`__mmask8` to `__mmask64`)

Operations on Masks



- Operations on masks: `kand`, `knand`, `knot`, `kor`, `kxnor`, `kxor`
 - `__mmask16 _kand (__mmask16 a, __mmask16 b)`
- Masks are automatically converted to integers
- To count number of bit set to 1: `__builtin_popcount(mask)`

Permute

- Permute (also called shuffle) a using the corresponding index in idx:
 - `__m512i _mm512_permutexvar_epi32 (__m512i idx, __m512i a)`
- A bit of misnomer, is not just shuffle or permute, but can also replicate elements
- Very powerful, can, e.g., be used to implement small, in-register look-up tables

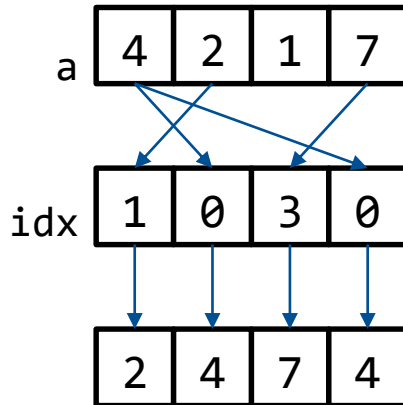

- Load 16 32-bit integers using 32-bit indices:
 - `__m512i _mm512_i32gather_epi32 (__m512i vindex, void const* base_addr, int scale)`
- Load 8 64-bit integers using 64-bit indices:
 - `__m512i _mm512_i64gather_epi64 (__m512i vindex, void const* base_addr, int scale)`
- Load 16 8-bit or 16-bit values (zero or sign extended)
 - `__m512i _mm512_i32extgather_epi32 (__m512i index, void const* mv, _MM_UPCONV_EPI32_ENUM conv, int scale, int hint)`
 - Indices are multiplied by scale, which must be 1, 2, 4 or 8
 - Gathering 8 elements performs 8 loads (using the 2 load units)
 - Is not necessary faster than individual loads (unless one needs the result in SIMD register anyway)

- Store 16 32-bit integers using 32-bit indices:
 - `void _mm512_i32scatter_epi32 (void* base_addr, __m512i vindex, __m512i a, int scale)`
- Store 8 64-bit integers using 64-bit indices:
 - `void _mm512_i64scatter_epi64 (void* base_addr, __m512i vindex, __m512i a, int scale)`
- Watch out for conflicts:
 - During a scatter, when multiple indices have the same value, bad things can happen
 - Test each element for equality with all other elements
 - `__m512i _mm512_conflict_epi32 (__m512i a)`

Selection example

```
uint32_t scalar_sel(int32_t* in, int32_t count, int32_t val, int32_t* out){
    uint32_t out_pos = 0;
    for (int32_t i=0; i < count; i++)
        if (in[i] < val)
            out[out_pos] = i;
    return out_pos;
}
```

```
uint32_t vector_sel(int32_t* in, int32_t count, int32_t val, int32_t* out){
    uint32_t out_pos = 0;
    __m512i cmp = __mm512_set1_epi32(val); for (int32_t i=0; i < count; i+=16) {
        __m512i inV = __mm512_loadu_si512(in+i);
        __mmask16 mask = __mm512_cmplt_epi32_mask(inV, cmp);
        __mm512_mask_compressorstoreu_epi32(out+out_pos, mask, inV);
        uint32_t count = __builtin_popcount(mask);
        out_pos += count;
    }
    return out_pos;
}
```

Decompression example (n-bit compression)

```
set k to 0
for i from 0 to max_index/simd_width_bits {
  for j from 0 to simd_width_bytes {
    parallel_load ba from input[k*simd_width_bytes + j*n];
    shuffle ba to ca using shuffle_mask(ma0, ..., ma{simd_width_bytes-1});
    parallel_shift ca by (sa0, ..., sa{bits_shifted});
    parallel_store ca in output[i* simd_width_bytes + j*8];
    parallel_load bb from input[k* simd_width_bytes + j*n + n/2];
    shuffle bb to cb using shuffle_mask(mb0, ..., mb{simd_width_bytes-1});
    parallel_shift bc by (sb0, ..., sb{bits_shifted});
    parallel_store cb in output[i* simd_width_bytes + j*8 + 4];
  }
  increase k by n;
}
```